

partner

excelencia e innovación



VINS | WINE

SAVERGLASS

Avenida Parque Isidora 1063 Enea | Pudahuel | Santiago | Chile
ventas@partnersa.cl | Tel. +56 2 429 28 00 | www.partnersa.cl



WINE

VIN S

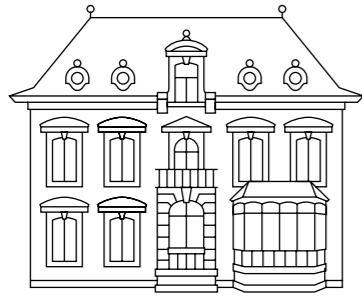

1897

CRÉATION DE LA VERRERIE
CREATION OF THE GLASS FACTORY

à Feuquières (FR)
in Feuquières (FR)

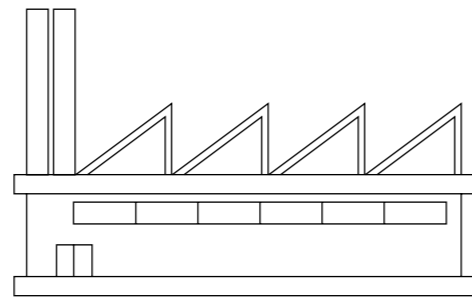

6

SITES DE PRODUCTION DE VERRE
GLASS FACTORIES

Feuquières, Le Havre, Arques (FR), Ghlin (BE),
Ras Al Khaimah (EAU) (UAE) – Acatlán de Juárez (Jalisco, MX)



4

SITES DE DÉCORATION
DECORATION FACTORIES

Feuquières, Arques, Coulommiers (FR)
Acatlán de Juárez (Jalisco, MX)

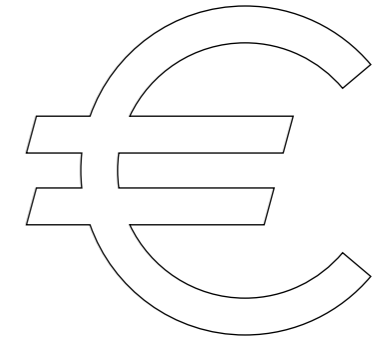

786 M€ / 794 M\$

CHIFFRE D'AFFAIRES EN 2022
TOTAL SALES IN 2022

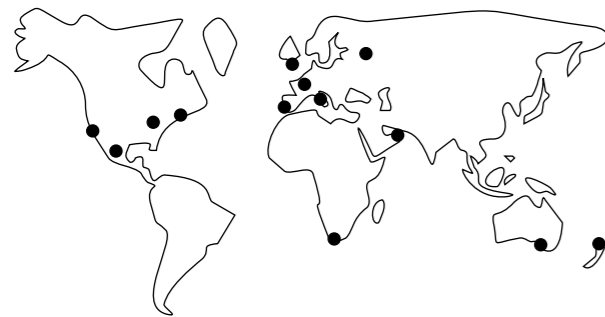

17

FILIALES AU NIVEAU MONDIAL
DISTRIBUTION SUBSIDIARIES
& OFFICES WORLDWIDE

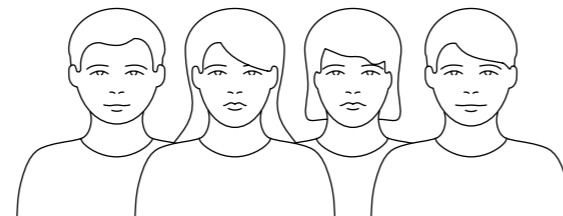

3 700

COLLABORATEURS
PEOPLE

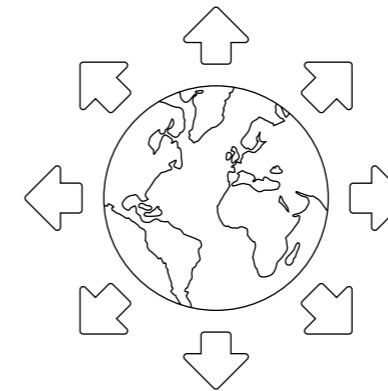

100

PAYS D'EXPORTATION
EXPORTING IN MORE THAN
100 COUNTRIES

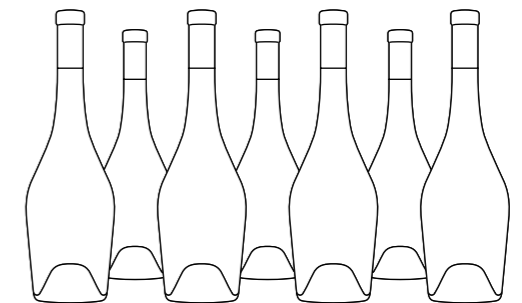

530 000

TONNES PRODUITES PAR AN
TONS PER YEAR

KEY FIGURES
CHIFFRES CLÉS

RÉPARTITION
DE L'ACTIVITÉ
DISTRIBUTION
OF ACTIVITY



72%
SPIRITUEUX
SPIRITS



27%
VINS
WINE



1%
AUTRES
OTHERS



Spécialiste mondial de la fabrication, de la personnalisation et de la décoration des bouteilles haut de gamme en verre, Saverglass est reconnu pour son innovation, son expertise verrière, la qualité de ses produits et de leur design. Saverglass est le partenaire privilégié des designers, des créateurs de marques et des vins premium et haut de gamme.

As a global specialist in manufacturing, customizing and decorating premium glass bottles, Saverglass is renowned for its innovation, glass-making expertise, product design and quality. Saverglass is the partner of choice for designers, brand creators, and premium and top-class wine producers.

DESIGN THAT CREATES VALUE

LE DESIGN, CRÉATEUR DE VALEUR

SAVERGLASS donne naissance, depuis plus de trente ans, à une offre de bouteilles de vins unique, dont la particularité est portée par l'originalité et la qualité de ses designs, travaillés dans les moindres détails: piqûres ou semelles singulières, courbes des épaulements, bagues originales, hauteurs et conicités des flacons. L'utilisation minutieuse des codes du design se voit renforcée par la brillance, l'éclat et la transparence des objets conférés par la qualité du verre conçue dans ses usines et travaillée par ses verriers: le verre «Extra-Blanc de SAVERGLASS®» et la teinte Antique.

Avec plus de 110 gammes, la collection de modèles vins offre une profondeur au travers de références oscillant entre 18,7 cl et 600 cl, lui permettant aujourd'hui de s'imposer comme l'offre la plus complète du marché. Elle s'enrichit, par ailleurs, chaque année, de nouvelles formes et de nouveaux concepts issus de la recherche du pôle marketing de l'entreprise.

SAVERGLASS has been creating a unique range of wine bottles for over 30 years. They owe their distinctive style to the originality and quality of their finely detailed designs: unusual punts and bases, curves of the shoulders, original finishes, height and taper of the bottle. The meticulous use of the design codes is enhanced by the brightness, radiance, and transparency of the bottles owing to the quality of the glass, which is designed in its factories and shaped by its glassmakers: the "Saverglass Extra White®" flint glass and the Antique Green color.

With more than 110 product ranges, the collection of wine models is available in various sizes, with products ranging between 18.7 cl and 6 L, making it the most comprehensive offer on the market today. More product ranges are added every year, with new shapes and concepts that have been developed from research in the company's marketing division.

A UNIQUE, COMPLETE RANGE OF PRODUCTS!

UNE OFFRE GLOBALE UNIQUE!





SAVERGLASS accentue les possibilités de différenciation et de sophistication par la mise à disposition d'un éventail d'options de personnalisation, telles que : les teintes de verre (existantes ou à personnaliser), les gravures, mais aussi de nombreuses options de décoration : sérigraphies précieuses, organiques ou émaillés ; coatings, partiels ou dégradés, brillants ou mats, transparents ou opaques ; satinage, sablage, ART & TOUCH ou la décoration en 3D ; l'irisation... jusqu'à la pose d'accessoires (« pierre précieuse », pièce métallique ou cuir...).

SAVERGLASS offre donc un champ extrêmement vaste de solutions au service de l'ultra-personnalisation haut de gamme, soit autant de réponses aux marques en quête de différenciation et de création de valeur !

SAVERGLASS also provides an array of customization options to highlight how products can be sophisticated and made to stand out even more. These options include glass colors (ready to order or customizable), engravings, and many decoration options, such as precious metal, organic or enamel screen printing; full, partial or graded coating using gloss, matte, transparent or opaque finishes; frosted finish from acid-etching or sandblasting, ART & TOUCH or embossing; iridescent coating; and accessory fittings (gemstone, metal or leather items, for example).

SAVERGLASS offers an extremely broad range of products geared toward premium quality and ultra-customization, meaning that there is a whole host of solutions for those brands that seek to stand out from the crowd and create value.

DIFFERENTIATE YOURSELF

SE DIFFÉRENCIER DAVANTAGE

1 SÉLECTION D'UN MODÈLE

SELECTION OF A DESIGN



COLLECTION DE MODÈLES
ORIGINAUX DE SAVERGLASS
SAVERGLASS ORIGINAL
DESIGNS COLLECTION

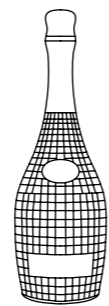

MODÈLE SPÉCIFIQUE
CUSTOM DESIGN

2 COULEURS DE VERRE

GLASS COLORS

EXTRA BLANC®
EXTRA WHITE®



TEINTES CLASSIQUES
CLASSIC COLORS



Antique
Antique Green



Jaune Clair
Amber



Jaune Foncé
Dark Amber



Champagne
Champagne Green

SELECT COLORS®



Vert Empire
Empire Green



Moka



Water Green

ONYX®



Noir
Black

3 GRAVURES

ENGRAVINGS



BAGUE
FINISH

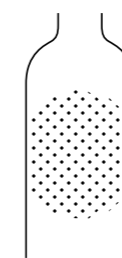

CORPS
BODY

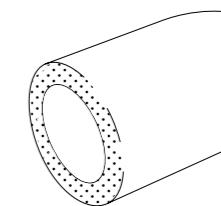

PLAN DE POSE
BASE

4 DÉCORATION

DECORATION

SÉRIGRAPHIE
ORGANIQUE
ORGANIC SCREEN
PRINTING

SÉRIGRAPHIE ÉMAIL
ET MÉTAUX PRÉCIEUX
ENAMEL & PRECIOUS
METAL SCREEN PRINTING

MARQUAGE À CHAUD
HOT STAMPING

COATINGS

SAVERBOX®

SATINAGE
ACID-ETCHING

SABLAGE
SANDBLASTING

ART & TOUCH®

IRISATION
IRIDESCENT EFFECT

MÉTALLISATION
METALLIZATION

CHROMOS
DECALS

ACCESSOIRES
ACCESSORIES



SELECTION OF A MODEL

1 SÉLECTION D'UN MODÈLE



EXTRA BLANC® PAR SAVERGLASS
EXTRA WHITE FLINT® BY SAVERGLASS



TEINTES CLASSIQUES
CLASSIC COLORS

GLASS COLORS
2 TEINTES DE VERRE



SELECT COLORS® VERT EMPIRE, MOKA, WATER GREEN, ONYX
 SELECT COLORS® EMPIRE GREEN, MOKA, WATER GREEN, ONYX



DARK AMBER
 JAUNE FONCÉ



CORPS
BODY

ENGRAVINGS
3 GRAVURES



**ÉPAULE
SHOULDER**

**PLAN
DE POSE
BASE**



**BAGUE
FINISH**



SÉRIGRAPHIE
ORGANIQUE
ORGANIC
SCREEN
PRINTING



COATING

SÉRIGRAPHIE
ÉMAIL
ET MÉTAUX PRÉCIEUX
ENAMEL AND
PRECIOUS METALS
SCREEN
PRINTING



SAVERBOX®



MARQUAGE
À CHAUD
HOT
STAMPING



SATINAGE
ACID
ETCHING



SABLAGE
SANDBLASTING



MÉTALLISATION
METALLIZATION

ART
& TOUCH®



MÉTAUX
PRÉCIEUX
PRECIOUS
METALS



IRISATION
IRIDESCENT
EFFECT



ACCESSOIRES
ACCESSORIES



VINTAGE DOURO



CONSTANCE SUPERBIA



CAUDALIE



ICON



PARADIS PERSONNALISÉE CUSTOM PARADIS



GRAND APPARAT



BORDELAISE 1855



SAINT-PIERRE



ICON



BORDELAISE ANCIENNE

BORDEAUX ACHIEVEMENTS RÉALISATIONS BORDELAISES



BOURGOGNE TERROIR



MAXIMA



AGAPE



BOURGOGNE 1859 PERSONNALISÉE CUSTOM BOURGOGNE 1859



SABINE



BOURGOGNE 1859 PERSONNALISÉE CUSTOM BOURGOGNE 1859



BOURGOGNE TERROIR

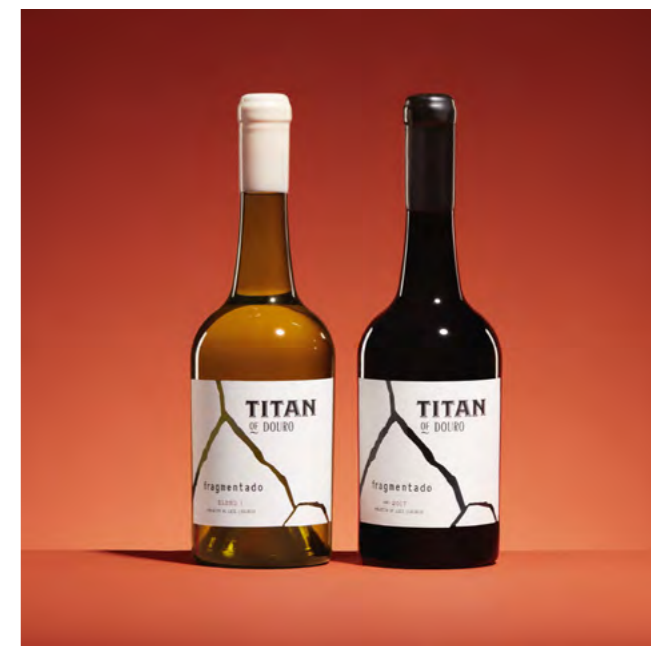

BOURGOGNE CRU CLASSÉ



AGAPE PERSONNALISÉE CUSTOM AGAPE



MARQUISE

BURGUNDY ACHIEVEMENTS RÉALISATIONS BOURGOGNES



BOURGOGNE ET BORDELAISE ANTIK



ALTO PYRAMID



POMPADOUR WINE



BORDELAISE INVENT



INSOLENCE



IRRÉSISTIBLE LINES



SOLSTICE LUNE DESCENDANTE



ÉCLAT GALAXY



KENDO WINE



DUO

NEW CONCEPTS ACHIEVEMENTS
RÉALISATIONS
NOUVEAUX CONCEPTS



BOURGOGNE ANTIK



SOPHIA



IRRÉSISTIBLE PERSONNALISÉE CUSTOM IRRÉSISTIBLE



INSOLENCE



BORDELAISE CRU CLASSÉ



ÉCLAT CONSTELLATION



TASTEVINE CONSTELLATION



AIKIDO



BOURGOGNE TERROIR



MAXIMA PERSONNALISÉE CUSTOM MAXIMA

ROSÉ WINE ACHIEVEMENTS RÉALISATIONS ROSÉS

PLATE CORK

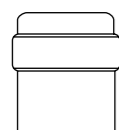
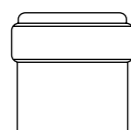

PLATE UNIQUE



PLATE

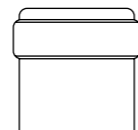

PLATE SB 29

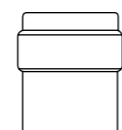

PLATE SB 31

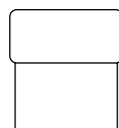

PLATE BOUCHON À TÊTE

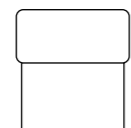

PLATE FA

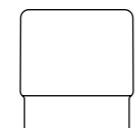

PLATE FA HT 22

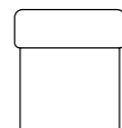

PLATE SPIRIT

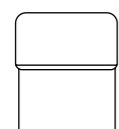

PLATE VDL

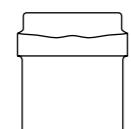
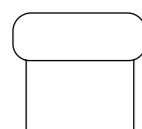
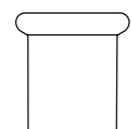

PLATE DÉFORMÉE

SPÉCIALE SPECIAL



CORDON



CORDON WINE

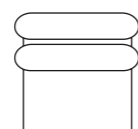

DOUBLE CORDON

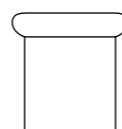

FLANGE

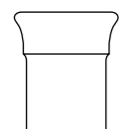

LOTUS

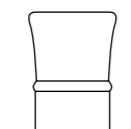

FLEUR

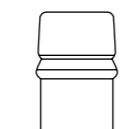

ILOISE 2

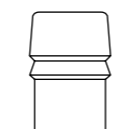

ILOISE PORTO

FINISHES
BAGUES

CARRÉE SQUARE

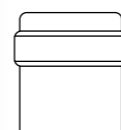

CARRÉE

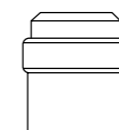

CARRÉE 36

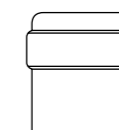
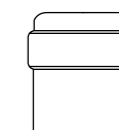
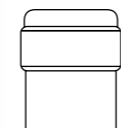
CARRÉE BOURGOGNE
CLASSIQUECARRÉE BOURGOGNE
SB29

CARRÉE SPÉCIALE

BVS SCREW CAP

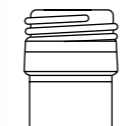

BVP 25 H 43

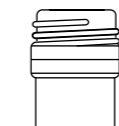

BVS 30H60

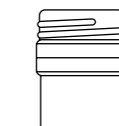

BVS 31,5H60

EFFERVESCENT SPARKLING

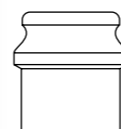

COURONNE CHAMP. 29

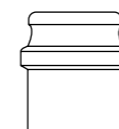

COURONNE & CARRÉE 29

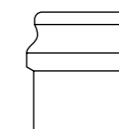

COURONNE CHAMP. 36

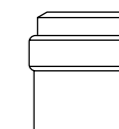

CARRÉE CHAMP. 36

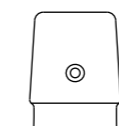

MCA2 73

MÉCANIQUE
SWINGTOP



EXTRA PREMIUM

Il s'agit du segment le plus haut de gamme de la collection Saverglass. On y trouve des modèles souvent complexes à produire en process automatique, de par leurs formes ou leurs caractéristiques, et qui sont dédiés à des cuvées élitistes. Le souci du détail est omniprésent. Ces bouteilles de luxe se différencient par: la hauteur conséquente des piqûres, le choix des bagues proposées sortant des standards pour une offre personnalisée, la hauteur des bouteilles hors norme, le poids de verre élevé, signe de richesse et de qualité, des épaulements travaillés, les plans de pose lisses, une conicité parfois prononcée. This is the top range of the Saverglass collection. It includes designs that are often too complex to manufacture using automated processes, due to their shapes or characteristics, and are intended for elite vintages. Attention to detail is unmistakable throughout. These luxurious bottles stand out because of their deep punts, finish options which go far beyond those normally available making them customizable and exceptionally tall, as well as the use of heavy glass which is a sign of opulence and quality, with fine lines, smooth bases, and sometimes pronounced conicity.



SUPER PREMIUM

Il s'agit du cœur de gamme de l'offre Saverglass. On y trouve des formes de bouteilles au design travaillé, des formes pouvant sortir des codes standards utilisés dans l'univers du vin, des piqûres aux formes avant-garde, des épaulements plats, des sections qui s'affranchissent du rond. Tous ces détails distinctifs viennent enrichir les formes du catalogue Saverglass et visent à apporter aux vins un positionnement haut de gamme. This is the core range of the Saverglass collection. They are intricately crafted bottles that go beyond the standard shapes used in the wine world, to offer avant-garde punts, flat shoulders and concepts that go beyond round. All these distinctive details enrich the options offered in the Saverglass catalog and are designed to enhance the status and positioning of your wine.

STANDINGS



PREMIUM +

C'est l'alliance du design et d'un positionnement prix attractif. Ce sont des modèles qui apportent de la différenciation (piqûre gravée, bas-fût gravé ...) tout en assurant une parfaite fonctionnalité au quotidien. On y trouve des bagues plus standards et des poids de verre maîtrisés. This range is where design and attractive price positioning come together in perfect harmony. These models stand out from the crowd (engraved punt, engraved heel, etc.), while ensuring perfect everyday functionality. They offer more-standard finish options and controlled glass weight.



PREMIUM

Un Segment qui se situe juste au-dessus du Standard Premium. Les modèles qui y figurent ont des dimensions proches des modèles standards, mais se singularisent par une originalité en terme de design; ils affichent un positionnement tarifaire attractif tout en conjuguant lignes modernes et minimalistes et poids de verre maîtrisés entre 500 et 650 g. A Segment just above Standard Premium. Their designs are close to standard, but stand out for their originality; they are attractively priced and feature modern minimalist lines and weigh between 500 and 650 g.



STANDARD PREMIUM

Il s'agit de l'entrée de gamme chez Saverglass. Ce sont des formes standards, classiques, aux dimensionnels standards sur le marché des vins, mais fabriqués selon le cahier des charges qualité Saverglass: contrôles permanents tout au long du process pour garantir les productions, attention particulière apportée à la brillance du verre et à l'aspect de la peau de verre. This is the entry range at Saverglass. Here, our customers will find classic industry-standard shapes and dimensions elevated to Saverglass quality specifications, continuous checks to guarantee the quality of the manufacturing process, and meticulous attention to intensifying the brilliance and sheen of the glass.

EXTRA PREMIUM	PAGE	PROF. GAMME	18,7 CL	20 CL	25 CL	37,5 CL	50 CL	75 CL	150 CL	300 CL	500 CL	600 CL
BORDELAISE 1855	46	1						●				
BORDELAISE ALEKA	48	1						●				
BORDELAISE	50	1						●				
CONSTANCE SUPERBIA								●				
BORDELAISE CRU CLASSE	52	1						●				
BORDELAISE GRAND APPARAT	54	1						●				
BORDELAISE HERMÈS	56	1						●				
BORDELAISE MERCURE	58	1						●				
BORDELAISE VINO SANTO	60	1						●				
BOURGOGNE 1859	128	2						●	●			
BOURGOGNE CRU CLASSE	130	1						●				
BOURGOGNE LA BARONNE	132	2						●				
BOURGOGNE LA DIVINE	134	1						●				
BOURGOGNE TERROIR	136	2						●	●			

SUPER PREMIUM	PAGE	PROF. GAMME	18,7 CL	20 CL	25 CL	37,5 CL	50 CL	75 CL	150 CL	300 CL	500 CL	600 CL
BORDELAISE ALIÉNOR	62	3					●	●	●			
BORDELAISE APPARAT	64	1						●				
BORDELAISE BELLISSIMA WINE	66	7				●	●	●	●			
BORDELAISE CONSTANCE	68	1						●				
BORDELAISE PARADIS	70	1						●				
BORDELAISE SAINT-PIERRE	72	2						●	●			
VINTAGE DOURO	74	1						●				
VINTAGE PORTO	76	1						●				
BOURGOGNE BOURGEOISE	138	1						●				
BOURGOGNE DIANE	140	1						●				
BOURGOGNE MARQUISE	142	1						●				
BOURGOGNE MAXIMA	144	3						●	●	●		
BOURGOGNE SABINE	146	1						●				
NOUVEAUX CONCEPTS AIKIDO	182	1						●				
NOUVEAUX CONCEPTS ICARO WINE	184	3					●	●	●			
NOUVEAUX CONCEPTS ESSENCIA WINE	186	2						●	●			
NOUVEAUX CONCEPTS FENG WINE	188	1						●				
NOUVEAUX CONCEPTS ICON DUOMO	190	1						●				
NOUVEAUX CONCEPTS INSOLENCIA	192	2						●				
NOUVEAUX CONCEPTS KENDO WINE	192	2			●			●				
NOUVEAUX CONCEPTS MASSALIA	196	1						●				
NOUVEAUX CONCEPTS POMPADOUR WINE	198	2						●	●			
NOUVEAUX CONCEPTS SOLSTICE	298	1						●				
NOUVEAUX CONCEPTS THEOS WINE	202	1						●				
FLÛTE ALLEGRO	218	2					●	●	●			
FLÛTE ALTUS	220	3				●		●	●			

PREMIUM +	PAGE	PROF. GAMME	18,7 CL	20 CL	25 CL	37,5 CL	50 CL	75 CL	150 CL	300 CL	500 CL	600 CL
BORDELAISE ALIÉNOR 2	78	1						●				
BORDELAISE ANCIENNE	80	2						●	●			
BORDELAISE BAMBOO WINE	82	2						●	●			
BORDELAISE BYBLOS 2	84	1						●				
BORDELAISE ICON	86	2						●	●			
BORDELAISE RIVIERA	88	1						●	●			
BORDELAISE SIGNATURE	90	3					●	●	●			
BOURGOGNE ATLAS	148	1						●				
BOURGOGNE CÉLESTE	150	1						●				
BOURGOGNE CHARDONNAY	152	1						●				
BOURGOGNE TASTEVINE	154	2						●	●			
BOURGOGNE SYNERGY	156	1						●			●	
BOURGOGNE VIN GRAND CRU	156	2						●	●			
NOUVEAUX CONCEPTS ALTO	204	1						●				
NOUVEAUX CONCEPTS ANTIK	206	2						●	●			
NOUVEAUX CONCEPTS ÉCLAT	209	3						●	●	●		
NOUVEAUX CONCEPTS IRRESISTIBLE	212	2						●	●			
NOUVEAUX CONCEPTS MERVEILLEUSE	214	2						●	●			
NOUVEAUX CONCEPTS SOPHIA	216	3						●	●			
NOUVEAUX CONCEPTS TASTEVINE CONSTELLATION	218	1						●				
NOUVEAUX CONCEPTS VIN GRAND CRU ZEBRA	220	1						●				

PREMIUM	PAGE	PROF. GAMME	18,7 CL	20 CL	25 CL	37,5 CL	50 CL	75 CL	150 CL	300 CL	500 CL	600 CL
BORDELAISE CAPRI	92	1						●				
BORDELAISE CAUDALIE	94	1						●				
BORDELAISE EDEN	96	1						●				
BORDELAISE MAESTRIA	98	1						●				
BOURGOGNE AGAPE	158	3						●	●			
BOURGOGNE AMARANTE	160	2						●	●			
NOUVEAUX CONCEPTS INVENT	222	1						●				

STANDARD PREMIUM	PAGE	PROF. GAMME	18,7 CL	20 CL	25 CL	37,5 CL	50 CL	75 CL	150 CL	300 CL	500 CL	600 CL
BORDELAISE ANCIENNE 2	100	1						●				
BORDELAISE CAPRICE	102	1						●				
BORDELAISE CHÂTEAU	104	1						●				
BORDELAISE PREMIÈRE	111	5				●	●	●	●	●		
BORDELAISE SANTIAGO	114	1						●				
BORDELAISES TRADITION	117	7				●	●	●	●	●	●	●
CLASSIC BORDELAISE	107	3				●	●	●				
BOURGOGNE CÉPAGE	162	1						●				
BOURGOGNE CLASSIQUE	174	1						●				
BOURGOGNE GRAVILLE	164	1						●				
BOURGOGNE GRAND MILLESIME	166	1						●				
BOURGOGNE PRESTIGE	168	2				●	●	●				
BOURGOGNES TRADITION	171	4						●	●	●	●	
FLÛTE ALTUS WINE	222	5				●	●	●	●	●	●	
FLÛTE TRADITION	224	1						●				
FLÛTE VIN CLUB	226	5				●	●	●	●	●		

STILL WINES — RANGE DEPTH OVERVIEW

VINS TRANQUILLES — RÉCAPITULATIF PROFONDEUR DE GAMMES

VINS TRAN QUILLES LLES

STILL WINES

BORDELAISE 1855	46
BORDELAISE ALEKA	48
BORDELAISE ALIÉNOR	62
BORDELAISE ALIÉNOR 2	78
BORDELAISE APPARAT	64
BORDELAISE ANCIENNE	80
BORDELAISE ANCIENNE 2	100
BORDELAISE BAMBOO WINE	82
BORDELAISE BELLISSIMA WINE	66
BORDELAISES BVS	123
BORDELAISE BYBLOS 2	84
BORDELAISE CAPRI	92
BORDELAISE CAPRICE	102
BORDELAISE CAUDALIE	94
BORDELAISE CHÂTEAU	104
CLASSIC BORDELAISE	107
BORDELAISE CONSTANCE	68
BORDELAISE CONSTANCE SUPERBIA	50
BORDELAISE CRU CLASSÉ	52
BORDELAISE EDEN	96
BORDELAISE GRAND APPARAT	54
BORDELAISE HERMÈS	56
BORDELAISE ICON	86
BORDELAISE MAESTRIA	98
BORDELAISE MERCURE	58
BORDELAISE PARADIS	70
BORDELAISES PERSONNALISÉES	120
BORDELAISE PREMIÈRE	111
BORDELAISE RIVIERA	88
BORDELAISE SAINT-PIERRE	72
BORDELAISE SANTIAGO	114
BORDELAISE SIGNATURE	90
BORDELAISES TRADITION	117
BORDELAISE TRAD. PREMIUM	119
BORDELAISE VINO SANTO	60
VINTAGE PORTO	76
VINTAGE DOURO	74
BOURGOGNE 1859	128
BOURGOGNE AGAPE	158
BOURGOGNE AMARANTE	160

BOURGOGNE ATLAS	148
BOURGOGNE BOURGEOISE	138
BOURGOGNES BVS	177
BOURGOGNE CÉLESTE	150
BOURGOGNE CÉPAGE	162
BOURGOGNE CHARDONNAY	152
BOURGOGNE CLASSIQUE	174
BOURGOGNE CRU CLASSÉ	130
BOURGOGNE DIANE	140
BOURGOGNE LA BARONNE	132
BOURGOGNE LA DIVINE	134
BOURGOGNE GRAND MILLÉSIME	166
BOURGOGNE GRAVILLE	164
BOURGOGNE MARQUISE	142
BOURGOGNE MAXIMA	144
BOURGOGNES PERSONNALISÉES	174
BOURGOGNE PRESTIGE	168
BOURGOGNE SABINE	146
BOURGOGNE SYNERGY	156
BOURGOGNE TASTEVINE	154
BOURGOGNE TERROIR	136
BOURGOGNES TRADITION	171
BOURGOGNE VIN GRAND CRU	156
FLÛTE ALLEGRO	218
FLÛTE ALTUS	220
FLÛTE ALTUS WINE	222
FLÛTE TRADITION	224
FLÛTE VIN CLUB	226
FLÛTE VIN CLUB BVS	226
NOUVEAUX CONCEPTS AIKIDO	182
NOUVEAUX CONCEPTS ALTO	204
NOUVEAUX CONCEPTS ANTIK	206
NOUVEAUX CONCEPTS ÉCLAT	209
NOUVEAUX CONCEPTS ESSENCIA WINE	186
NOUVEAUX CONCEPTS FENG WINE	188
NOUVEAUX CONCEPTS ICARO WINE	184
NOUVEAUX CONCEPTS ICON DUOMO	190
NOUVEAUX CONCEPTS INSOLENCIE	192
NOUVEAUX CONCEPTS INVENT	222
NOUVEAUX CONCEPTS IRRESISTIBLE	212
NOUVEAUX CONCEPTS KENDO WINE	194
NOUVEAUX CONCEPTS MASSALIA	196
NOUVEAUX CONCEPTS MERVEILLEUSE	214
NOUVEAUX CONCEPTS POMPADOUR WINE	198
NOUVEAUX CONCEPTS SOLSTICE	200
NOUVEAUX CONCEPTS SOPHIA	216
NOUVEAUX CONCEPTS TASTEVINE CONSTELLATION	218
NOUVEAUX CONCEPTS THEOS WINE	202
NOUVEAUX CONCEPTS VIN GRAND CRU ZEBRA	220

ALPHABETICAL TABLE OF CONTENTS

SOMMAIRE ALPHABÉTIQUE

 BORDELAISE 1855 P. 46	 BORDELAISE ALEKA P. 48	 BORDELAISE ALIÉNOR P. 62	 BORDELAISE ALIÉNOR 2 P. 78	 BORDELAISE APPARAT P. 64	 BORDELAISE ANCIENNE P. 80
 BORDELAISE ANCIENNE 2 P. 100	 BORDELAISE P. 115	 BORDELAISE BAMBOO WINE P. 82	 BORDELAISE BELLISSIMA WINE P. 66	 BORDELAISE BYBLOS 2 P. 84	 BORDELAISE CAPRI P. 92
 BORDELAISE CAPRICE P. 102	 BORDELAISE CAUDALIE P. 94	 BORDELAISE CHÂTEAU P. 104	 CLASSIC BORDELAISE P. 107	 BORDELAISE CONSTANCE P. 68	 BORDELAISE CONSTANCE SUPERBIA P. 50
 BORDELAISE CRU CLASSÉ P. 52	 BORDELAISE EDEN P. 96	 BORDELAISE GRAND APPARAT P. 54	 BORDELAISE HERMÈS P. 56	 BORDELAISE ICON P. 86	 BORDELAISE MAESTRIA P. 98
 BORDELAISE MERCURE P. 58	 BORDELAISE PARADIS P. 70	 BORDELAISE PREMIÈRE P. 111	 BORDELAISE RIVIERA P. 88	 BORDELAISE SAINT-PIERRE P. 72	 BORDELAISE SANTIAGO P. 114
 BORDELAISE SIGNATURE P. 90	 BORDELAISES TRADITION P. 117	 BORDELAISE VINO SANTO P. 60	 VINTAGE PORTO P. 76	 VINTAGE DOURO P. 74	 BOURGOGNE 1859 P. 128
 BOURGOGNE AGAPE P. 158	 BOURGOGNE AMARANTE P. 160	 BOURGOGNE ATLAS P. 148	 BOURGOGNE BOURGEOISE P. 138	 BOURGOGNE CÉLESTE P. 150	 BOURGOGNE CÉPAGE P. 162

SOMMAIRE VISUEL VISUAL TABLE OF CONTENTS

 BOURGOGNE CHARDONNAY P. 152	 BOURGOGNE CLASSIQUE P. 174	 BOURGOGNE CRU CLASSÉ P. 130	 BOURGOGNE DIANE P. 140	 BOURGOGNE LA BARONNE P. 132	 BOURGOGNE LA DIVINE P. 134
 BOURGOGNE GRAND MILLÉSIME P. 166	 BOURGOGNE GRAVILLE P. 164	 BOURGOGNE MARQUISE P. 142	 BOURGOGNE MAXIMA P. 144	 BOURGOGNE PRESTIGE P. 168	 BOURGOGNE SABINE P. 146
 BOURGOGNE SYNERGY P. 156	 BOURGOGNE TASTEVINE P. 154	 BOURGOGNE TERROIR P. 136	 BOURGOGNES TRADITION P. 171	 BOURGOGNE VIN GRAND CRU P. 156	 FLÛTE ALLEGRO P. 220
 FLÛTE ALTUS P. 222	 FLÛTE ALTUS WINE P. 224	 FLÛTE TRADITION P. 226	 FLÛTE VIN CLUB P. 228	 FLÛTE VIN CLUB BVS P. 228	 NOUVEAUX CONCEPTS AIKIDO P. 182
 NOUVEAUX CONCEPTS ALTO P. 204	 NOUVEAUX CONCEPTS ANTIK P. 206	 NOUVEAUX CONCEPTS ICARO WINE P. 184	 NOUVEAUX CONCEPTS ÉCLAT P. 209	 NOUVEAUX CONCEPTS ESSENCIA WINE P. 186	 NOUVEAUX CONCEPTS FENG WINE P. 188
 NOUVEAUX CONCEPTS ICON DUOMO P. 190	 NOUVEAUX CONCEPTS INSOLENCE P. 192	 NOUVEAUX CONCEPTS INVENT P. 222	 NOUVEAUX CONCEPTS IRRÉSISTIBLE P. 212	 NOUVEAUX CONCEPTS KENDO WINE P. 194	 NOUVEAUX CONCEPTS MASSALIA P. 214
 NOUVEAUX CONCEPTS MERVEILLEUSE P. 214	 NOUVEAUX CONCEPTS POMPADOUR WINE P. 198	 NOUVEAUX CONCEPTS SOLSTICE P. 200	 NOUVEAUX CONCEPTS SOPHIA P. 216	 NOUVEAUX CONCEPTS TASTEVINE CONSTELLATION P. 220	 NOUVEAUX CONCEPTS THEOS WINE P. 218
 NOUVEAUX CONCEPTS VIN GRAND CRU ZEBRA P. 220					

BOR DE LAI SES

BORDEAUX SHAPES

BORDELAISE 1855

EXTRA PREMIUM



Authentique «bouteille d'époque», la BORDELAISE 1855 reproduit la forme originelle de la bouteille de Bordeaux. Elle restitue cet équilibre parfait entre le col, la bague, la silhouette conique et la piqûre très profonde au plan de pose étroit et lisse. Ne se prêtant à aucune des concessions esthétiques de la production industrielle, la Bordelaise 1855 élève cette bouteille de vin au statut de flacon de luxe.



An authentic "vintage bottle", the Bordelaise 1855 reproduces the shape of the original Bordeaux bottle. It offers slim smooth lines with a deep punt and a perfectly balanced neck and finish. Making none of the aesthetic concessions usual in industrial production, the BORDELAISE 1855 elevates this wine bottle to the status of a luxury flask.



BORDELAISE 1855



BORDELAISE 1855 À CRAN WITH NOTCH

Contenance Capacity	75 cl 25.36 oz	75 cl 25.36 oz
Référence Reference	3817	4003
Bague Finish	 Plate SB 29,5	 Plate SB 29,5
Poids Weight	760 g 26.81 oz	760 g 26.81 oz
Hauteur totale [A] Overall height	300,5 mm 11.83 in	300,5 mm 11.83 in
Diamètre Pied [B] Base diameter	79,4 mm 3.13 in	79,4 mm 3.13 in
Diamètre Épaule [C] Shoulder diameter	84,8 mm 3.34 in	84,8 mm 3.34 in
Diamètre de débouchage [D] Entrance bore diameter	18,5 mm 0.73 in	18,5 mm 0.73 in
Teinte Glass color	● Antique Antique Green	● Antique Antique Green ○ Extra Blanc* Extra White Flint

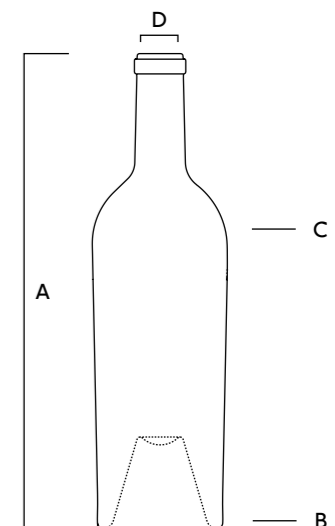

* : Sur commande Made to order
Modèle déposé « Design Saverglass »
Registered "Design Saverglass"

BORDELAISE ALEKA

EXTRA PREMIUM



D'origine grecque, le nom d'ALEKA est le diminutif d'Alexandra. Ce nom de reine s'applique parfaitement bien à cette bouteille d'une grâce souveraine déclinée du modèle Bordelaise PARADIS. Sa silhouette imposante et majestueuse résulte de sa forme conique et de son poids de verre exceptionnel : 1200 g. Qui dit mieux ? Loin de « peser » sur sa ligne, ce poids conforte son élégant port de reine et positionne le modèle comme le plus luxueux dans sa catégorie.

The name ALEKA, of Greek origin, is the diminutive for Alexandra. This queen's name suits this bottle particularly well, with its sovereign graciousness inherited from the Bordelaise PARADIS. Its imposing and majestic silhouette comes from its conical shape and its exceptional weight of 1200g. Far from "weighing down" on its line, this mass reinforces its elegance and positions this item as the most luxurious in its category.



Contenance
Capacity

75 cl
25.36 oz

Référence
Reference

3638

Bague
Finish



Carrée Bourgogne Classique

Poids
Weight

1200 g
42.33 oz

Hauteur
totale [A]
Overall
height

325,8 mm
12.83 in

Diamètre
Pied [B]
Base
diameter

80,3 mm
3.16 in

Diamètre
Épaule [C]
Shoulder
diameter

87,6 mm
3.45 in

Diamètre de
débouchage
[D] Entrance
bore diameter

18,5 mm
0.75 in

Teinte
Glass color

● Antique
Antique Green

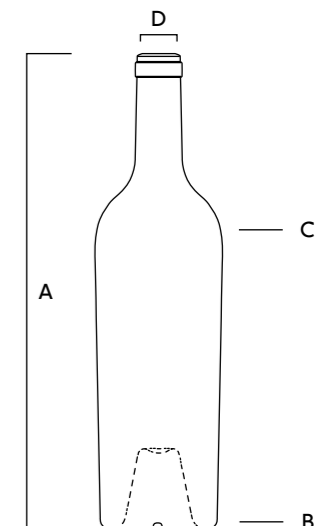

BORDELAISE CONSTANCE SUPERBIA





EXTRA PREMIUM



D'inspiration bordelaise, CONSTANCE SUPERBIA séduit par sa silhouette gracile. Sa conicité couplée à un épaulement charnu dessine avec élégance une bouteille au profil généreux et statutaire. Mais c'est sa piqûre profonde qui l'inscrit définitivement dans la catégorie des flacons « à part » et uniques, imaginés pour sublimer de précieux contenus, fruits du travail de toute une année.

Inspired by the Bordelaise, CONSTANCE SUPERBIA seduces with its graceful silhouette. Its tapered shape coupled with a strong shoulder produce a bottle with a generous and statuesque elegance. But it is the deep punt that places it definitively in the category of "different class" and unique flasks, created to enhance its precious content, CONSTANCE SUPERBIA is the fruit of an entire year's design work.



Contenance Capacity	75 cl 25.36 oz	75 cl 25.36 oz
Référence Reference	5020	5020*
Bague Finish	 Carrée Bourgogne Classique	 Plate FA
Poids Weight	1200 g 42.33oz	1200 g 42.33oz
Hauteur totale [A] Overall height	334 mm 13.15 in	333,6 mm 13.13 in
Diamètre Pied [B] Base diameter	73,3 mm 2.89 in	73,3 mm 2.89 in
Diamètre Épaule [C] Shoulder diameter	88,9 mm 3.50 in	88,9 mm 3.50 in
Diamètre de débouchage [D] Entrance bore diameter	18,5 mm 0.73 in	18,5 mm 0.73 in
Teinte Glass color	 Antique Antique Green	 Antique Antique Green

* : Sur commande Made to order
Modèle déposé « Design Saverglass »
Registered "Design Saverglass"

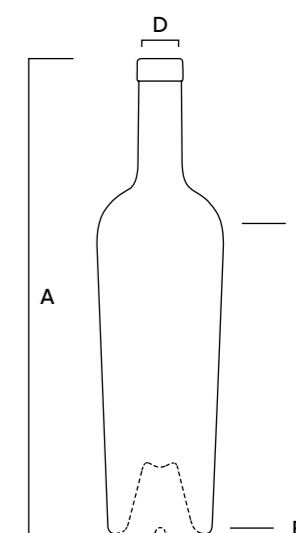

BORDELAISE CRU CLASSÉ

EXTRA PREMIUM



En reproduisant fidèlement les caractéristiques des flacons d'antan, la Bordelaise Cru Classé signe ici une véritable prouesse technique: sa piqûre exceptionnelle de 75 mm de profil carré reste, à ce jour, la plus profonde jamais réalisée en procédé automatique. Avec une hauteur de 312 mm, un col fin légèrement plus long que le standard habituel et un épaulement haut et carré particulièrement marqué, l'héritière de l'illustre bordelaise allie élégance et distinction. Sa subtile conicité révèle enfin l'aura exceptionnelle de ce flacon destiné aux plus grands crus.

The faithful reproduction of vintage bottle features proves that the Bordelaise Cru Classé is a real feat of craftsmanship. To this day, its exceptional 75mm square punt remains the deepest measurement ever achieved by automated processes. This successor to the illustrious bordelaise style marries elegance and distinction with a height of 312mm, a slender neck extending slightly more than usual, and a particularly distinct high, broad shouldering. Lastly, its subtle tapering draws out the distinct appearance of this bottle, which is intended for use with the finest wines.



Contenance
Capacity

75 cl
25.36 oz

Référence
Reference

6068

Bague
Finish



Poids
Weight

995 g
35.10 oz

Hauteur
totale [A]
Overall
height

312 mm
12.28 in

Diamètre
Pied [B]
Base
diameter

81,4 mm
3.20 in

Diamètre
Épaule [C]
Shoulder
diameter

84,5 mm
3.33 in

Diamètre de
débouchage
[D] Entrance
bore diameter

18,5 mm
0.73 in

Teinte
Glass color

● Antique
Antique Green
○ Extra Blanc
Extra White Flint

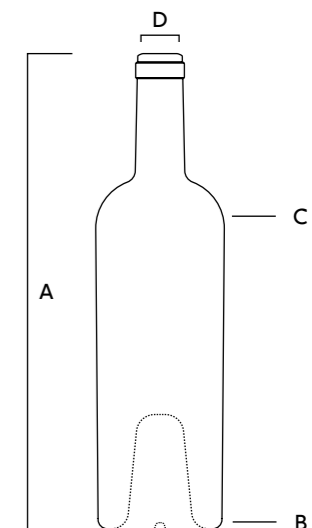

BORDELAISE GRAND APPARAT

EXTRA PREMIUM



Contenance
Capacity

75 cl
25.36 oz

Référence
Reference

4308

Bague
Finish



Plate SB 30

Poids
Weight

1200 g
42.33 oz

Hauteur
totale [A]
Overall
height

315,8 mm
12.43 in

Diamètre
Corps [B]
Body
diameter

85,3 mm
3.36 in

Diamètre de
débouchage
[C] Entrance
bore diameter

18,5 mm
0.73 in

Teinte
Glass color

● Antique
Antique Green

Par son poids de verre extrême de 1200 g et la puissance de sa silhouette, la Bordelaise GRAND APPARAT se positionne dans la catégorie «extra-premium» des bouteilles à vocation vin de Saverglass. Ce flacon d'exception s'adresse prioritairement aux grands vins de terroir et de propriétaire. Son épaulement très caractéristique, la forme solide et terrienne de son corps cylindrique, sa bague spéciale et le profil carré de sa profonde piqure traduisent cette image «domaine», authentiquement respectueuse des racines et des valeurs de reconnaissance du monde vinicole.

With its extreme 1200g glass weight and the power of its silhouette, the GRAND APPARAT Bordelaise is positioned in the "extra premium" category of Saverglass' wine bottles. This outstanding bottle is intended primarily for vintage local and grower's wines. Its highly characteristic shoulder, the solid, aristocratic shape of its cylindrical body, its distinctive finish and the square profile of its deep punt convey an "estate" image, authentically respectful of the roots and recognition values of the wine-growing world.

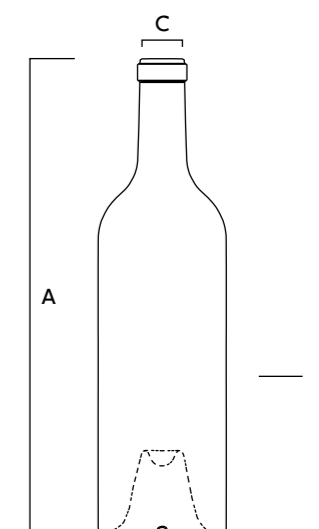

BORDELAISE HERMÈS

EXTRA PREMIUM



Charismatique, la Bordelaise HERMÈS captive par sa beauté classique et son élégant équilibre des proportions. Dotée d'un poids de verre de 1000 g, elle affiche une bague carrée, une épaule galbée et une piqûre profonde qui participent à l'image statutaire et à la prestance du modèle.



The classic beauty and elegantly balanced proportions of the charismatic Bordelaise HERMÈS are captivating. Weighing 1,000g, it boasts a square finish, a sloped shoulder and a deep punt that all contribute to the statuesque poise of this model.



HERMÈS



HERMÈS BVS

Contenance Capacity	75 cl 25.36 oz	75 cl 25.36 oz
Référence Reference	5591	4048
Bague Finish	 Carrée	 BVS 31,5H60
Poids Weight	1020 g 35.98 oz	998 g 35.20 oz
Hauteur totale [A] Overall height	312,3 mm 12.30 in	312,3 mm 12.30 in
Diamètre Pied [B] Base diameter	78 mm 3.07 in	77,8 mm 3.06 in
Diamètre Épaule [C] Shoulder diameter	86,5 mm 3.41 in	86,3 mm 3.40 in
Diamètre de débouchage [D] Entrance bore diameter	18,5 mm 0.73 in	20 mm 0.79 in
Teinte Glass color	● Antique Antique Green	● Antique Antique Green

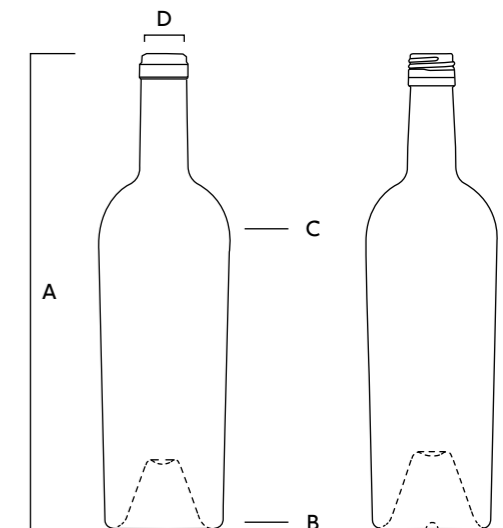

Modèle déposé « Design Saverglass »
Registered "Design Saverglass"

BORDELAISE MERCURE

EXTRA PREMIUM



La Bordelaise MERCURE impose sa silhouette statutaire et puissante, non sans lien de parenté avec le modèle HERMÈS. Elle se caractérise par le galbe de son épaule et sa profonde piqûre ainsi qu'un poids de verre exceptionnel de 1200 g. Ce qui lui permettra d'accompagner magistralement les crus les plus prestigieux.

The Bordelaise MERCURE stands out due to its statuesque, powerful shape, with a definite family resemblance to the HERMÈS. It is characterized by its sloped shoulder and its deep punt as well as the exceptional 1,200g glass weight, masterfully enhancing the most prestigious vintages.



Contenance Capacity	75 cl 25.36 oz
Référence Reference	5367*
Bague Finish	 Plate SB 31
Poids Weight	1197 g 42.22 oz
Hauteur totale [A] Overall height	312 mm 12.28 in
Diamètre Pied [B] Base diameter	81,4 mm 3.20 in
Diamètre Épaule [C] Shoulder diameter	90,1 mm 3.55 in
Diamètre de débouchage [D] Entrance bore diameter	17,5 mm 0.69 in
Teinte Glass color	● Antique Antique Green

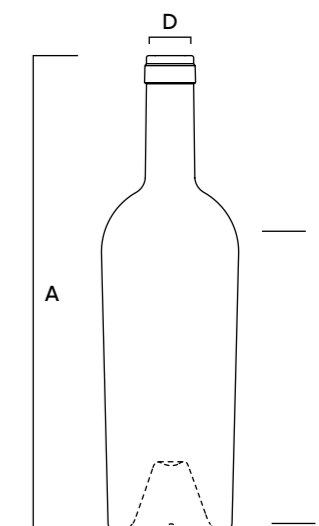

* : Sur commande Made to order
Modèle déposé « Design Saverglass »
Registered "Design Saverglass"

BORDELAISE VINO SANTO

EXTRA PREMIUM



Par son poids de verre extrême de 1200 g et la puissance de sa silhouette, la Bordelaise VINO SANTO se positionne dans la catégorie «extra-premium» des flacons d'exception. Une ligne élancée, un fût cylindrique, un rayon de jable nerveux et un col court surmonté d'une imposante bague constituent les points de singularité les plus remarquables de VINO SANTO.

With its extremely heavy 1,200g glass weight and striking shape, the VINO SANTO is definitely in the "extra premium" category of exceptional flasks. Sleek lines, a cylindrical base, a racy heel diameter, and a short neck mounted on an imposing finish are the most distinctive features of VINO SANTO.



Contenance
Capacity

75 cl
25.36 oz

Référence
Reference

4342

Bague
Finish



Carrée Bourgogne Classique

Poids
Weight

1203 g
42.43 oz

Hauteur
totale [A]
Overall
height

330,5 mm
13.01 in

Diamètre
Corps [B]
Body
diameter

82,7 mm
3.26 in

Diamètre de
débouchage
[C] Entrance
bore diameter

18,5 mm
0.73 in

Teinte
Glass color

● Antique
Antique Green

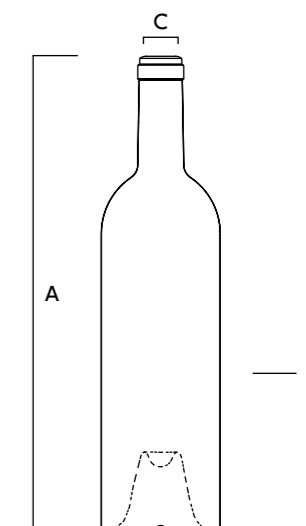

BORDELAISE ALIÉNOR



SUPER PREMIUM



Telle Aliénor d'Aquitaine, illustre reine médiévale, ALIÉNOR s'impose comme la digne héritière de la culture bordelaise. Épaulement caractéristique «Saint-Émilion», fût tronconique et piqûre très profonde munie d'une boudine pensée pour faciliter le service du sommelier, la gamme reprend tous les signes distinctifs des flacons d'autrefois.

Like Eleanor of Aquitaine, the famous medieval queen, ALIÉNOR stands out as a worthy heir to Bordeaux culture. With its characteristic "Saint-Émilion" shoulder, trunk-like base and very deep punt with a small "push-out inside the punt" designed to help the sommelier serve from it, the range boasts all the distinctive marks of vintage bottles.



Contenance Capacity	50 cl 16.91 oz	75 cl 25.36 oz	150 cl 50.73 oz
Référence Reference	3329	2260	6374
Bague Finish	 Plate Unique	 Plate Unique	 Carrée Spéciale
Poids Weight	600 g 21.16 oz	765 g 26.98 oz	1288 g 45.43 oz
Hauteur totale [A] Overall height	288 mm 11.34 in	313,7 mm 12.35 in	385,8 mm 15.19 in
Diamètre Pied [B] Base diameter	67 mm 2.64 in	77,5 mm 3.05 in	95,7 mm 3.77 in
Diamètre Épaule [C] Shoulder diameter	72,4 mm 2.85 in	83,5 mm 3.29 in	103,1 mm 4.06 in
Diamètre de débouchage [D] Entrance bore diameter	18,5 mm 0.73 in	18,5 mm 0.73 in	18,5 mm 0.73 in
Teinte Glass color	● Antique Antique Green ○ Extra Blanc Extra White Flint	● Antique Antique Green	● Antique Antique Green ○ Extra Blanc Extra White Flint

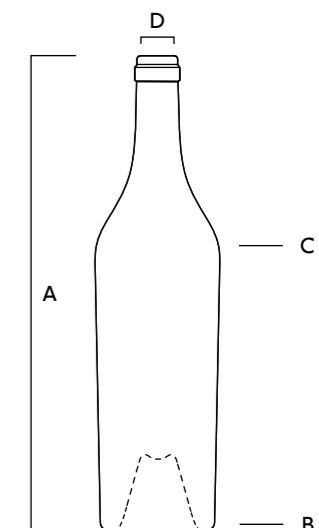

BORDELAISE APPARAT

SUPER PREMIUM



Puisant son inspiration parmi les bouteilles bordelaises anciennes, le modèle APPARAT revisite les lignes d'autrefois avec une véritable exigence d'authenticité. Affichant une silhouette plantureuse, APPARAT se caractérise par un jable de tout petit rayon et une piqûre profonde de forme carrée pourvue d'une boudine. Positionnée sur un col de fort diamètre, sa bague spéciale rehaussée d'un cordon se positionne très haut par rapport au buvant et renforce la typicité de ce modèle.

Drawing inspiration from the original Bordeaux bottles, APPARAT revisits the lines of yesteryear with striking authenticity. With its full silhouette, APPARAT stands out with its very small heel diameter and deep, square punt with a small "push-out inside the punt". Positioned on a wide neck, its special cord-wrapped finish is very high and quintessential to this design.



Contenance
Capacity

75 cl
25.36 oz

Référence
Reference

2698

Bague
Finish

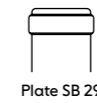

Plate SB 29

Poids
Weight

794 g
28.01 oz

Hauteur
totale [A]
Overall
height

300 mm
11.81 in

Diamètre
Corps [B]
Body
diameter

81 mm
3.19 in

Diamètre de
débouchage
[C] Entrance
bore diameter

18,5 mm
0.73 in

Teinte
Glass color

● Antique
Antique Green

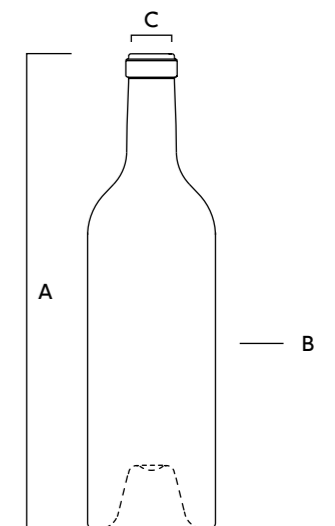

BORDELAISE BELLISSIMA WINE





SUPER PREMIUM



La ligne BELLISSIMA WINE attire tous les regards. Elle se démarque par sa silhouette fuselée et originale, gage d'une visibilité exceptionnelle en point de vente. Un caractère généreux qui n'autorise aucun compromis et vient renforcer les valeurs d'excellence d'un contenu de grande qualité.

The BELLISSIMA WINE line never fails to turn heads. Distinguished by its streamlined, original silhouette, exceptional in-store visibility is guaranteed. A generous character allows no compromise and reinforces the value and excellence of its top-quality contents.



Contenance Capacity	37,5 cl 12.68 oz	50 cl 16.91 oz	75 cl 25.36 oz	150 cl 50.73 oz
Référence Reference	1782	1717	1718*	2397
Bague Finish	 Plate Spirit	 Plate Spirit	 Plate Spirit	 Plate bouchon à tête
Poids Weight	510 g 17.99 oz	665 g 23.46 oz	725 g 25.57 oz	1300 g 45.86 oz
Hauteur totale [A] Overall height	331 mm 13.03 in	352 mm 13.86 in	352 mm 13.86 in	480 mm 18.90 in
Diamètre Corps [D] Body diameter	55,8 mm 2.20 in	62,6 mm 2.46 in	73,8 mm 2.91 in	87 mm 3.43 in
Diamètre de débouchage [E] Entrance bore diameter	18,5 mm 0.73 in	18,5 mm 0.73 in	18,5 mm 0.73 in	21,5 mm 0.85 in
Teinte Glass color	● Antique Antique Green ○ Extra Blanc Extra White Flint	● Antique Antique Green ○ Extra Blanc Extra White Flint	● Antique Antique Green ○ Extra Blanc Extra White Flint	● Antique Antique Green ○ Extra Blanc Extra White Flint

* : Sur commande Made to order
Modèle déposé « Design Saverglass »
Registered "Design Saverglass"

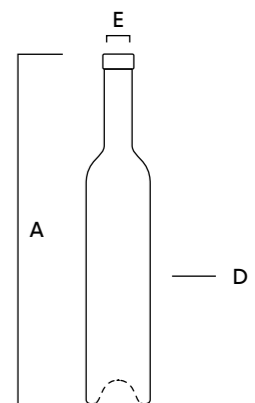

BORDELAISE CONSTANCE

SUPER PREMIUM



Dans la lignée des Bordelaises, CONSTANCE joue la carte du chic intemporel. Marquée par une conicité soulignée, une épaule charnue et une piqûre profonde, elle dessine les lignes d'un flacon sélect et original.

In the Bordeaux range, CONSTANCE plays the timeless chic card. Tapered, with a sloped shoulder and deep punt, it has the lines of an exclusive and original flask.



Contenance
Capacity

75 cl
25.36 oz

75 cl
25.36 oz

Référence
Reference

5019

5019

Bague
Finish

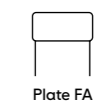

Poids
Weight

860 g
30.34 oz

860 g
30.34 oz

Hauteur
totale [A]
Overall
height

318 mm
12.52 in

317,6 mm
12.50 in

Diamètre
Pied [B]
Base
diameter

71,6 mm
2.82 in

71,6 mm
2.82 in

Diamètre
Épaule [C]
Shoulder
diameter

86,9 mm
3.42 in

86,9 mm
3.42 in

Diamètre de
débouchage
[D] Entrance
bore diameter

18,5 mm
0.73 in

18,5 mm
0.73 in

Teinte
Glass color

● Antique
Antique Green

● Antique
Antique Green

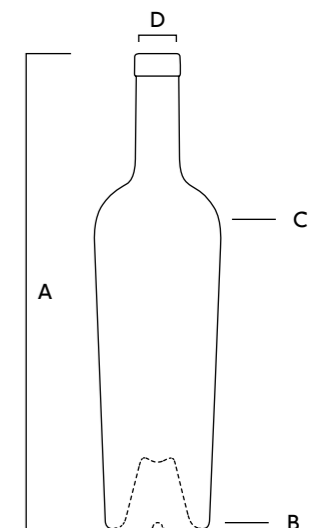

Modèle déposé « Design Saverglass »
Registered "Design Saverglass"

BORDELAISE PARADIS

SUPER PREMIUM



La bouteille PARADIS tire son inspiration d'un authentique modèle bordelais du 19^{ème} siècle. La grâce du flacon résulte d'un parfait équilibre de proportions, d'une silhouette altière et conique, et d'une épaule aux courbes délicates. Son poids de verre élevé, sa bague carrée, et la profondeur de sa piquère participent à son caractère aristocratique. De facture ancienne, la Bordelaise PARADIS se révèle étonnamment contemporaine par la justesse de sa ligne.

The PARADIS bottle draws its inspiration from an authentic 19th century Bordeaux model. The bottle's grace stems from the perfectly balanced proportions of its slender, conical shape and delicately curved shoulders. Its heavy glass content, square finish and a deep punt give it a distinctly aristocratic air. Though crafted in a traditional style, the slim lines of the Bordelaise PARADIS give it a surprisingly contemporary look.



Contenance
Capacity

75 cl
25.36 oz

Référence
Reference

3441

Bague
Finish



Carrée Bourgogne Classique

Poids
Weight

840 g
29.63 oz

Hauteur
totale [A]
Overall
height

311 mm
12.24 in

Diamètre
Pied [B]
Base
diameter

77,7 mm
3.06 in

Diamètre
Épaule [C]
Shoulder
diameter

84,7 mm
3.33 in

Diamètre de
débouchage
[D] Entrance
bore diameter

18,5 mm
0.73 in

Teinte
Glass color

● Antique
Antique Green

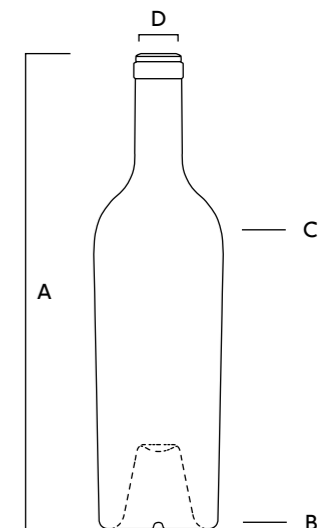

Modèle déposé « Design Saverglass »
Registered "Design Saverglass"

BORDELAISE SAINT-PIERRE

SUPER PREMIUM



Travaillé sur la base d'un poids de verre généreux, le design de la Bordelaise SAINT-PIERRE se singularise par un fût cylindrique, un rayon de jable nerveux et un col court de fort diamètre, surmonté d'une imposante bague carrée bourgogne. À travers ses lignes pures et fluides, le modèle SAINT-PIERRE exprime une grande élégance intemporelle, matinée de modernité.

With its generous glass weight, the design of the Bordelaise SAINT-PIERRE stands out with its cylindrical base, a racy heel diameter and short wide neck, on which rests an imposing square Bordeaux finish. Its pure, flowing lines give SAINT-PIERRE a grand, timeless elegance, with a touch of modernity.



Contenance Capacity	75 cl 25.36 oz	75 cl 25.36 oz	150 cl 50.73 oz
Référence Reference	T298	3832*	3783
Bague Finish	 Carrée Bourgogne	 BVS 31.5H60	 Carrée
Poids Weight	785 g 27.69 oz	780 g 27.51 oz	1115 g 39.33 oz
Hauteur totale [A] Overall height	312 mm 12.28 in	312 mm 12.28 in	380 mm 14.96 in
Diamètre Corps [B] Body diameter	78 mm 3.07 in	78,9 mm 3.11 in	95 mm 3.74 in
Diamètre de débouchage [C] Entrance bore diameter	18,5 mm 0.73 in	20,5 mm 0.81 in	18,5 mm 0.73 in
Teinte Glass color	● Antique Antique Green	● Antique Antique Green	● Antique Antique Green

* : Sur commande Made to order
Modèle déposé « Design Saverglass »
Registered "Design Saverglass"

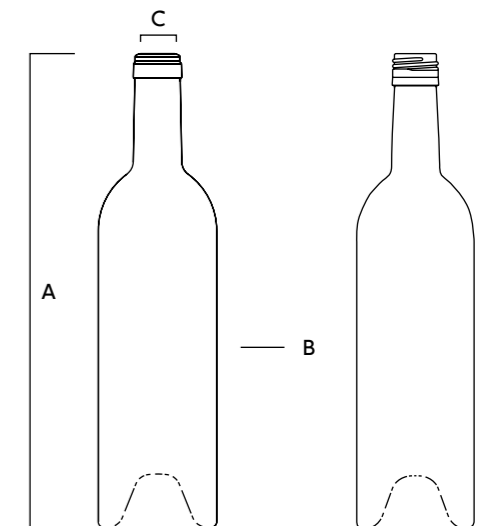

VINTAGE DOURO

SUPER PREMIUM



VINTAGE DOURO a été spécifiquement pensée pour le conditionnement des vins de Porto les plus prestigieux. Imaginé dans le plus pur respect des lignes traditionnelles des bouteilles type Porto, ce modèle s'applique à parfaire certains détails, tant esthétiques que fonctionnels. Son épaule très arrondie souligne la forme galbée du mollet bas-col destiné à recueillir le dépôt du vin lors de la phase de vieillissement. Un sommet de col cylindrique surmonté d'une bague iloise ou d'une bague plate garantit par ailleurs une parfaite étanchéité.

VINTAGE DOURO is specially designed to showcase the most prestigious Port wines. Created with utmost respect for the traditional lines of Port bottles, this model sets out to perfect aesthetic and functional details. Its very rounded shoulder emphasizes the sloped shape of the calf at the lower neck, designed to collect wine sediment during the aging stage. A cylindrical upper neck topped by a flat double collar Iloise finish or flat finish ensures a perfect seal.



Contenance
Capacity

75 cl
25.36 oz

75 cl
25.36 oz

Référence
Reference

2703

2703

Bague
Finish



Poids
Weight

660 g
23.28 oz

665 g
23.46 oz

Hauteur
totale [A]
Overall
height

296 mm
11.65 in

306,5 mm
12.07 in

Diamètre
Pied [B]
Base
diameter

74,5 mm
2.93 in

74,5 mm
2.93 in

Diamètre
Épaule [C]
Shoulder
diameter

82,2 mm
3.24 in

82,2 mm
3.24 in

Diamètre de
débouchage
[D] Entrance
bore diameter

18,5 mm
0.73 in

17 mm
0.67 in

Teinte
Glass color

● Antique
Antique Green

● Antique
Antique Green

● Jaune Foncé
Dark Amber

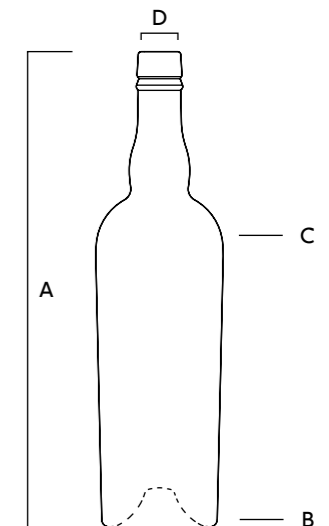

VINTAGE PORTO

SUPER PREMIUM



VINTAGE PORTO doit son nom au célèbre vin millésimé qui a vieilli au moins dix ans. De forme traditionnelle, cette bouteille se veut généreuse tant au niveau de son poids de verre que de ses proportions. Authentique et rassurante, VINTAGE PORTO signe ainsi l'origine et la noblesse des grands vins mutés du monde entier.

VINTAGE PORTO owes its name to the famous vintage wine that is aged for at least 10 years. With its traditional shape, this bottle is generous in both glass weight and proportions. Authentic and reassuring, VINTAGE PORTO testifies to the origin and nobility of the world's great still wines.



Contenance
Capacity

75 cl
25.36 oz

Référence
Reference

0011

Bague
Finish



Iloise Porto

Poids
Weight

700 g
24.69 oz

Hauteur
totale [A]
Overall
height

306,5 mm
12.07 in

Diamètre
Pied [B]
Base
diameter

74,5 mm
2.93 in

Diamètre
Épaule [C]
Shoulder
diameter

82,2 mm
3.24 in

Diamètre de
débouchage
[D] Entrance
bore diameter

18,5 mm
0.73 in

Teinte
Glass color

● Antique
Antique Green

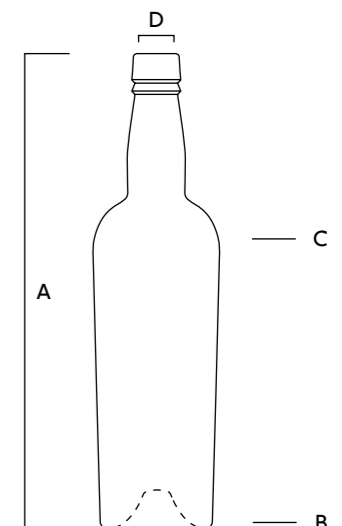

BORDELAISE ALIÉNOR 2

PREMIUM +



ALIÉNOR 2 propose une déclinaison épurée de la Bordelaise ALIÉNOR tout en conservant le tempérament de son design originel.

ALIÉNOR 2 offers a refined version of the Bordelaise ALIÉNOR while retaining the temperament of its original design.



Contenance
Capacity

75 cl
25.36 oz

Référence
Reference

2643

Bague
Finish



Plate Unique

Poids
Weight

700 g
24.69 oz

Hauteur totale [A]
Overall height

313,6 mm
12.35 in

Diamètre Pied [B]
Base diameter

74,7 mm
2.94 in

Diamètre Épaule [C]
Shoulder diameter

80,8 mm
3.18 in

Diamètre de débouchage [D]
Entrance bore diameter

18,5 mm
0.75 in

Teinte
Glass color

● Antique
Antique Green
○ Extra Blanc*
Extra White Flint

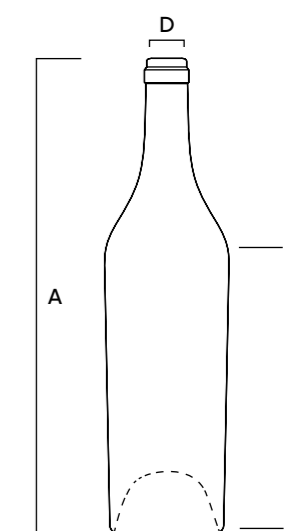

* : Sur commande Made to order
Modèle déposé « Design Saverglass »
Registered "Design Saverglass"

BORDELAISE ANCIENNE

PREMIUM +



De facture classique à l'élégance racée, la Bordelaise ANCIENNE décline avec style une forme conique, un très bel arrondi de l'épaule et une parfaite justesse dans les proportions.

Classically crafted with racy elegance, the Bordelaise ANCIENNE offers a stylish tapered shape, beautifully rounded shoulders and perfect proportions.



Contenance
Capacity

75 cl
25.36 oz

150 cl
50.73 oz

Référence
Reference

1189*

T233

Bague
Finish

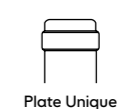

Poids
Weight

650 g
22.93 oz

920 g
32.45 oz

Hauteur
totale [A]
Overall
height

299 mm
11.77 in

359 mm
14.13 in

Diamètre
Pied [B]
Base
diameter

74,8 mm
2.94 in

91,3 mm
3.59 in

Diamètre
Épaule [C]
Shoulder
diameter

82,8 mm
3.26 in

101 mm
3.98 in

Diamètre de
débouchage
[D] Entrance
bore diameter

18,5 mm
0.73 in

18,5 mm
0.73 in

Teinte
Glass color

● Antique
Antique Green

● Antique
Antique Green

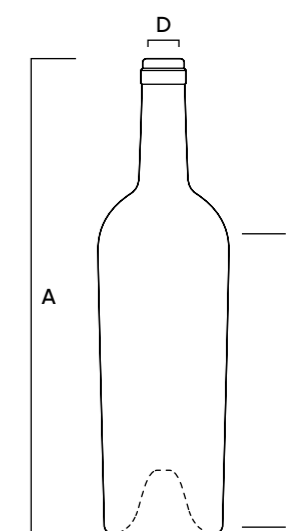

* : Sur commande Made to order
Modèle déposé « Design Saverglass »
Registered "Design Saverglass"

BORDELAISE BAMBOO WINE

PREMIUM +



Héritière de la ligne BELLISSIMA, BAMBOO WINE révèle toute sa modernité à travers une esthétique pure et une silhouette spectaculaire. Un trait précis, un style exigeant et très contemporain caractérisent cette bouteille.

A descendant of the BELLISSIMA line, BAMBOO WINE speaks of modernity with its pure aesthetic and spectacular silhouette. Precise lines and a very exacting and contemporary style characterize this bottle.



Contenance
Capacity

50 cl
16.91 oz

75 cl
25.36 oz

Référence
Reference

2424

2425

Bague
Finish

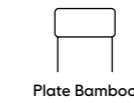

Plate Bamboo



Plate SB29

Poids
Weight

660 g
23.28 oz

620 g
21.87 oz

Hauteur
totale [A]
Overall
height

352 mm
13.86 in

341,5 mm
13.44 in

Diamètre
Corps [B]
Body
diameter

62 mm
2.44 in

72,6 mm
2.86 in

Diamètre de
débouchage
[C] Entrance
bore diameter

18,5 mm
0.73 in

18,5 mm
0.73 in

Teinte
Glass color

● Antique
Antique Green
○ Extra Blanc
Extra White Flint

● Antique
Antique Green
○ Extra Blanc
Extra White Flint

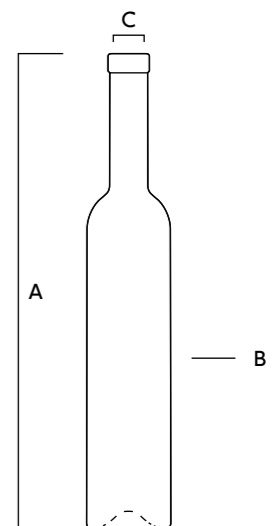

BORDELAISE BYBLOS 2

PREMIUM +



Le modèle BYBLOS 2 se distingue par sa silhouette contemporaine et son allure racée. Il affiche une haute stature, une légère conicité de fût, un col parfaitement cylindrique et une épaule discrète. Cette silhouette aux détails design subtils valorisera les vins les plus sélectifs.

BYBLOS 2 is distinctive in its contemporary silhouette and its racy looks. It speaks of high status with its slightly tapered base, perfectly cylindrical neck and discreet shoulder. This silhouette, with its subtle design details, will showcase the most exclusive wines.



BYBLOS 2



BYBLOS 2

Contenance
Capacity

75 cl
25.36 oz

75 cl
25.36 oz

Référence
Reference

5463

5463

Bague
Finish



Poids
Weight

679 g
23.95 oz

678 g
23.92 oz

Hauteur
totale [A]
Overall
height

327 mm
12.87 in

324,8 mm
12.79 in

Diamètre
Pied [B]
Base
diameter

70,6 mm
2.78 in

70,6 mm
2.78 in

Diamètre
Épaule [C]
Shoulder
diameter

79,6 mm
3.13 in

79,6 mm
3.13 in

Diamètre de
débouchage
[D] Entrance
bore diameter

18,5 mm
0.73 in

18,5 mm
0.73 in

Teinte
Glass color

● Antique
Antique Green
○ Extra Blanc
Extra White Flint

● Antique
Antique Green
○ Extra Blanc
Extra White Flint

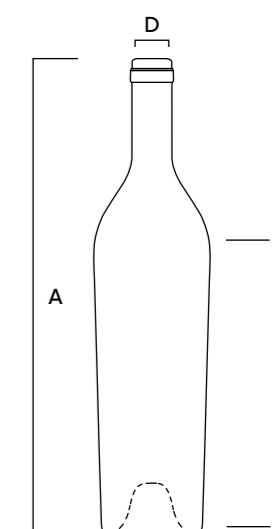

* : Sur commande Made to order
Modèle déposé « Design Saverglass »
Registered "Design Saverglass"

BORDELAISE ICON



PREMIUM +



Avec son design racé hérité des formes bordelaises classiques, le modèle ICON est une référence pour magnifier les grands vins.

With its racy design drawing on classic Bordeaux shapes, the ICON model is, as its name suggests, "iconic" thus enhancing great wines.



Contenance Capacity	75 cl 25.36 oz	75 cl 25.36 oz	150 cl 50.73 oz
Référence Reference	4387	6380	5163
Bague Finish	 Plate SB 29,5	 BVS 31,5H60	 Plate SB 29,5
Poids Weight	760 g 26.81 oz	768 g 27.09 oz	1218 g 42.96 oz
Hauteur totale [A] Overall height	308 mm 12.13 in	308 mm 12.13 in	376,1 mm 14.81 in
Diamètre Pied [B] Base diameter	75,8 mm 2.98 in	75,6 mm 2.98 in	94,2 mm 3.71 in
Diamètre Épaule [C] Shoulder diameter	82 mm 3.23 in	81,8 mm 3.22 in	101,9 mm 4.01 in
Diamètre de débouchage [D] Entrance bore diameter	18,5 mm 0.73 in	20 mm 0.79 in	18,5 mm 0.73 in
Teinte Glass color	● Antique Antique Green ○ Extra Blanc Extra White Flint	● Antique Antique Green	● Antique Antique Green ○ Extra Blanc* Extra White Flint

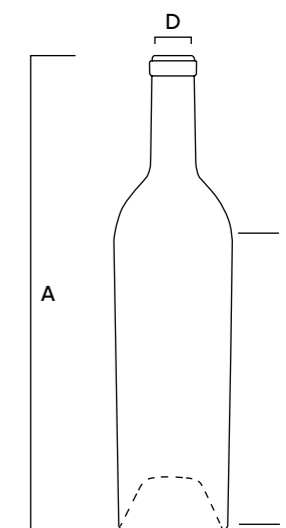

* : Sur commande Made to order
Modèle déposé « Design Saverglass »
Registered "Design Saverglass"

BORDELAISE RIVIERA

PREMIUM +



Déployant des proportions idéalement équilibrées, la Bordelaise RIVIERA séduira les amateurs de grandes contenances grâce à l'élégance de sa silhouette, son épaulement et son col généreux. Le design épuré du magnum RIVIERA mettra en scène de manière spectaculaire aussi bien les vins rosés grâce au verre Extra-Blanc, que les vins rouges et vins blancs en choisissant la teinte Antique.

With ideally balanced proportions, the Bordelaise RIVIERA will seduce lovers of grand containers by the elegance of its silhouette, its shoulder and its generous neck. The pure design of the RIVIERA magnum spectacularly showcases rosé wines in Extra White flint glass, as well as red and white wines in the Antique Green tint.



Contenance
Capacity

150 cl
50.73 oz

Référence
Reference

5183

Bague
Finish



Poids
Weight

979 g
34.53 oz

Hauteur
totale [A]
Overall
height

380 mm
14.96 in

Diamètre
Pied [B]
Base
diameter

91,3 mm
3.59 in

Diamètre
Épaule [C]
Shoulder
diameter

100,3 mm
3.95 in

Diamètre de
débouchage
[D] Entrance
bore diameter

18,5 mm
0.73 in

Teinte
Glass color

● Antique
Antique Green
○ Extra Blanc
Extra White Flint

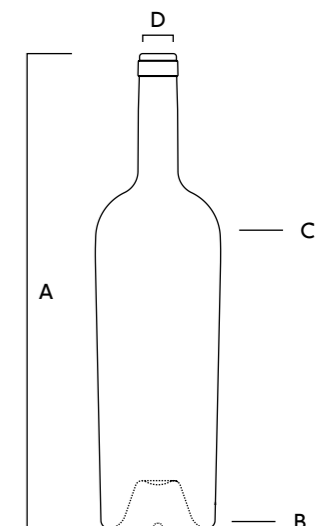

BORDELAISE SIGNATURE



PREMIUM +



Renouvelant le design plutôt classique des bouteilles destinées notamment aux vins du soleil et aux vins de cépage, le modèle SIGNATURE propose un contenant résolument innovant. Son col long et son fût conique prolongé par un talon affirment un positionnement moderne et audacieux.

Updating the more classic design of bottles and intended mainly for sunny wines and varietal wines, SIGNATURE offers a defiantly innovative container. Its long neck and tapered base with an extended heel give it a modern, daring look.



Contenance Capacity	50 cl 16.91 oz	75 cl 25.36 oz	150 cl 50.73 oz
Référence Reference	2672*	2284	2671*
Bague Finish	 Plate Unique	 Plate Unique	 Carrée Spéciale
Poids Weight	500 g 17.64 oz	700 g 24.69 oz	1155 g 40.74 oz
Hauteur totale [A] Overall height	289 mm 11.38 in	330 mm 12.99 in	406,5 mm 16.00 in
Diamètre Pied [B] Base diameter	69,3 mm 2.73 in	79,2 mm 3.12 in	98,7 mm 3.89 in
Diamètre Épaule [C] Shoulder diameter	69,3 mm 2.73 in	79,2 mm 3.12 in	98,7 mm 3.89 in
Diamètre de débouchage [D] Entrance bore diameter	18,5 mm 0.73 in	18,5 mm 0.73 in	18,5 mm 0.73 in
Teinte Glass color	● Antique Antique Green ○ Extra Blanc Extra White Flint	● Antique* Antique Green ○ Extra Blanc Extra White Flint	● Antique Antique Green ○ Extra Blanc Extra White Flint

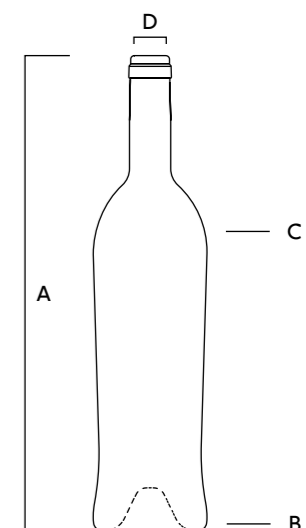

* : Sur commande Made to order
Modèle déposé « Design Saverglass »
Registered "Design Saverglass"

BORDELAISE CAPRI

PREMIUM



Longiligne, gracieuse et particulièrement fonctionnelle, la Bordelaise CAPRI esquisse une silhouette d'une pureté très actuelle. Son corps cylindrique et son épaulement arrondi s'expriment tout en légèreté (poids de verre de 600 g) pour obtenir un flacon à l'esthétique distinctive.

Sleek, graceful and particularly functional, the Bordelaise CAPRI shows a purity of shape that is very much today. Its cylindrical body and rounded shoulder speak of elegance (glass weight 600g) for an aesthetically distinctive bottle.



Contenance
Capacity

75 cl
25.36 oz

Référence
Reference

4616*

Bague
Finish

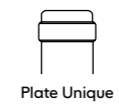

Poids
Weight

600 g
21.16 oz

Hauteur
totale [A]
Overall
height

315 mm
12.40 in

Diamètre
Corps [B]
Body
diameter

73,7 mm
2.90 in

Diamètre de
débouchage
[C] Entrance
bore diameter

18,5 mm
0.73 in

Teinte
Glass color

● Antique
Antique Green
○ Extra Blanc
Extra White Flint

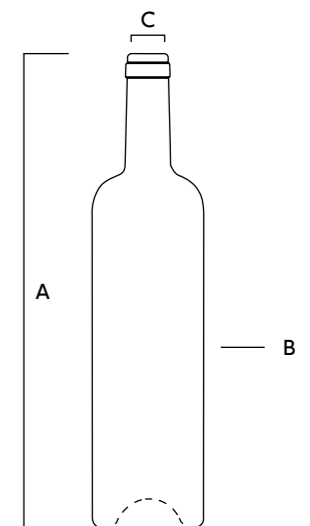

* : Sur commande Made to order
Modèle déposé « Design Saverglass »
Registered "Design Saverglass"

BORDELAISE CAUDALIE



PREMIUM



La Bordelaise CAUDALIE propose une version stylisée et rajeunie du modèle APPARAT. Ce classique de grand standing se renouvèle et s'allège grâce notamment à un diamètre corps réduit, une épaule singulière et un col doté d'une bague carrée. Autre apport de l'allègement: son positionnement tarifaire attractif.

The Bordelaise CAUDALIE offers a stylish more youthful version of APPARAT. This legendary classic has been modernized and slimmed with a narrower body, a distinctive shoulder and a neck with a square finish. Another slimline feature is its attractive price point.



Contenance Capacity	75 cl 25.36 oz	75 cl 25.36 oz
Référence Reference	3349	4518
Bague Finish	 Plate SB 29	 BVS 31,5H60
Poids Weight	600 g 21.16 oz	600 g 21.16 oz
Hauteur totale [A] Overall height	300 mm 11.81 in	300 mm 11.81 in
Diamètre Corps [B] Body diameter	77,5 mm 3.05 in	77,4 mm 3.05 in
Diamètre de débouchage [C] Entrance bore diameter	18,5 mm 0.73 in	20 mm 0.79 in
Teinte Glass color	● Antique Antique Green ○ Extra Blanc Extra White Flint	● Antique Antique Green ○ Extra Blanc* Extra White Flint

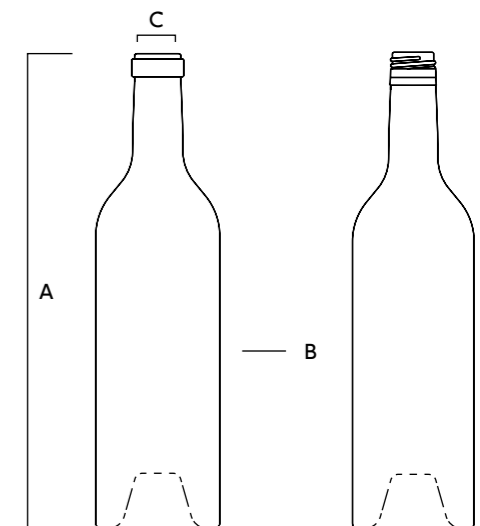

* : Sur commande Made to order
Modèle déposé « Design Saverglass »
Registered "Design Saverglass"

BORDELAISE EDEN

PREMIUM



La Bordelaise EDEN innove et surprend. Sa compacité dimensionnelle comparée à l'impression de volume qu'elle transmet la conforte sur un positionnement véritablement distinctif. Affichant un poids de verre de 600 g seulement, le modèle EDEN se singularise également par son profil de col surmonté d'une très belle bague carrée. La Bordelaise EDEN se rattache à une gamme composée de la Bordelaise PARADIS (840 g) et de la Bordelaise ALEKA (1200 g) qui offrent toutes deux une silhouette conique et un dessin d'épaule caractéristique.

The Bordelaise EDEN is innovative and surprising. Its compact size, compared to the impression it gives of volume, testifies to its comfortable positioning as a truly distinctive bottle. With a glass weight of only 600g, EDEN stands out due to the profile of its neck topped by a very beautiful square finish. The Bordelaise EDEN is part of a range that includes the PARADIS (840g) and ALEKA (1200g), each of which offers a tapered silhouette and characteristic designer shoulder.



Contenance
Capacity

75 cl
25.36 oz

Référence
Reference

4383

Bague
Finish



Carrée Bourgogne SB 29

Poids
Weight

600 g
21.16 oz

Hauteur
totale [A]
Overall
height

300 mm
11.81 in

Diamètre
Pied [B]
Base
diameter

74 mm
2.91 in

Diamètre
Épaule [C]
Shoulder
diameter

81 mm
3.19 in

Diamètre de
débouchage
[D] Entrance
bore diameter

18,5 mm
0.75 in

Teinte
Glass color

● Antique
Antique Green
○ Extra Blanc*
Extra White Flint

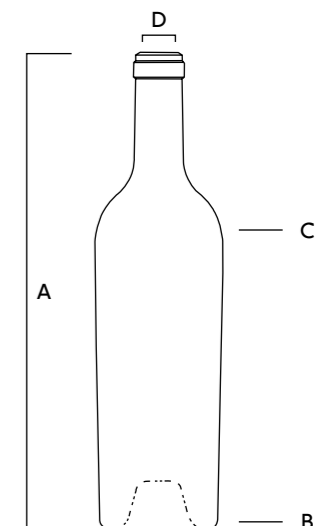

* : Sur commande Made to order
Modèle déposé « Design Saverglass »
Registered "Design Saverglass"

BORDELAISE MAESTRIA

PREMIUM



Rayon d'épaulement arrondi, fût conique, piqûre prononcée de 35 mm, hauteur traditionnelle de 313 mm... Si les bordelaises anciennes se distinguent à travers des détails très identifiables, MAESTRIA s'impose elle comme le modèle le plus compétitif de cette série affichant un poids plume de 600 g seulement.

Rounded shoulder, tapered base, pronounced 35mm punt, traditional 313mm height... If the Bordelaises of old had distinctive, very identifiable details, MAESTRIA stands out as the most competitive model of this series with a glass weight of just 600g.



Contenance
Capacity

75 cl
25.36 oz

75 cl
25.36 oz

Référence
Reference

5200

5200

Bague
Finish

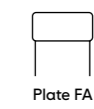

Poids
Weight

600 g
21.16 oz

600 g
21.16 oz

Hauteur
totale [A]
Overall
height

315 mm
12.40 in

313 mm
12.32 in

Diamètre
Pied [B]
Base
diameter

72,4 mm
2.85 in

72,4 mm
2.85 in

Diamètre
Épaule [C]
Shoulder
diameter

78,2 mm
3.08 in

78,2 mm
3.08 in

Diamètre de
débouchage
[D] Entrance
bore diameter

18,5 mm
0.73 in

18,5 mm
0.73 in

Teinte
Glass color

● Antique
Antique Green

● Antique
Antique Green

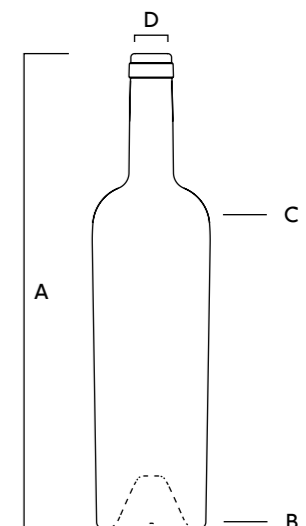

BORDELAISE ANCIENNE 2



STANDARD PREMIUM



Dans la lignée de la Bordelaise ANCIENNE, le modèle ANCIENNE 2 décline une version plus accessible. Reprenant les caractéristiques esthétiques qui ont fait le succès de la gamme ANCIENNE, elle conserve sa rondeur d'épaule et une élégante conicité.

In the Bordelaise ANCIENNE line, the ANCIENNE 2 is a more affordable version. With the aesthetic features that made the ANCIENNE range such a success, it retains its round shoulder and tapered elegance.



Contenance Capacity	75 cl 25.36 oz	75 cl 25.36 oz
Référence Reference	2784	3407
Bague Finish	 Plate Unique	 BVS 30H60
Poids Weight	600 g 21.16 oz	615 g 21.69 oz
Hauteur totale [A] Overall height	299 mm 11.77 in	299 mm 11.77 in
Diamètre Pied [B] Base diameter	74,1 mm 2.92 in	74,1 mm 2.92 in
Diamètre Épaule [C] Shoulder diameter	81,4 mm 3.20 in	81,4 mm 3.20 in
Diamètre de débouchage [D] Entrance bore diameter	18,5 mm 0.73 in	20 mm 0.79 in
Teinte Glass color	● Antique Antique Green ○ Extra Blanc* Extra White Flint	● Antique Antique Green

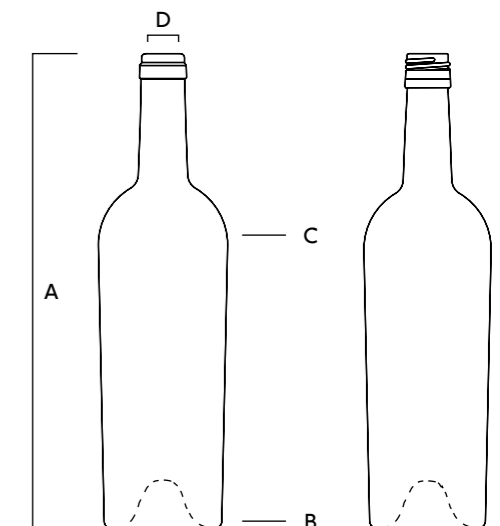

*: Sur commande Made to order

BORDELAISE CAPRICE

STANDARD PREMIUM



CAPRICE réinterprète les contours de la silhouette Bordelaise en y insufflant une touche de modernité. Elle conserve ainsi un corps cylindrique élancé et une épaule tout en rondeur. L'originalité ainsi que le renouvellement de la ligne s'expriment à travers un choix de bagues qui viennent personnaliser son long col.

CAPRICE reinterprets the lines of the classic Bordeaux silhouette by adding a touch of modernity. It retains a sleek cylindrical body and very round shoulder. Original and new are both featured in its choice of finishes to customize its long neck.



Contenance Capacity	75 cl 25.36 oz	75 cl 25.36 oz
Référence Reference	1731	1731
Bague Finish	 Plate FA	 Plate Unique
Poids Weight	620 g 21.87 oz	620 g 21.87 oz
Hauteur totale [A] Overall height	313 mm 12.32 in	315 mm 12.40 in
Diamètre Corps [B] Body diameter	76,2 mm 3.00 in	76,2 mm 3.00 in
Diamètre de débouchage [C] Entrance bore diameter	18,5 mm 0.73 in	18,5 mm 0.73 in
Teinte Glass color	● Antique Antique Green	● Antique Antique Green

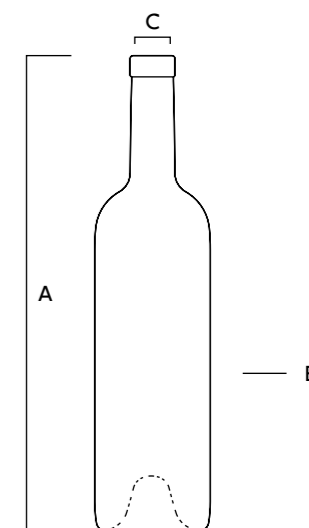

BORDELAISE CHÂTEAU

STANDARD PREMIUM



Contenance
Capacity

75 cl
25.36 oz

Référence
Reference

2040

Bague
Finish

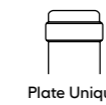

Plate Unique

Poids
Weight

605 g
21.34 oz

Hauteur
totale [A]
Overall
height

303 mm
11.93 in

Diamètre
Pied [B]
Base
diameter

74,4 mm
2.93 in

Diamètre
Épaule [C]
Shoulder
diameter

79,4 mm
3.13 in

Diamètre de
débouchage
[D] Entrance
bore diameter

18,5 mm
0.73 in

Teinte
Glass color

- Antique
Antique Green
- Champagne*
Champagne Green

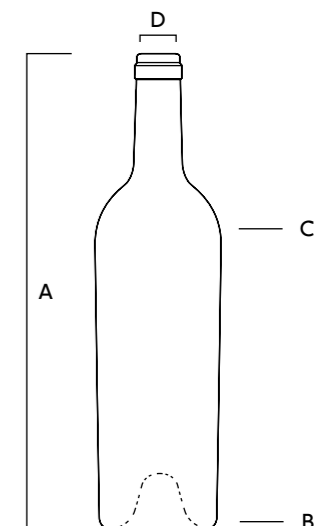

La bouteille CHÂTEAU constitue une première évolution de la Bordelaise TRADITION. Une légère conicité, une piqûre accentuée, et une hauteur conforme au modèle de référence forment les principaux atouts de ce modèle.

CHÂTEAU is the first evolution of the Bordelaise TRADITION. Its slightly tapered shape, accentuated punt, and classic height are the main features of this model.

* : Sur commande Made to order

CLASSIC BORDELAISE

STANDARD PREMIUM



Le modèle CLASSIC BORDELAISE ravive ingénieusement la silhouette générique de la Bordelaise, tout en préservant ses grandes qualités de praticité. Une ligne haute et fine, des dimensions généreuses, un épaulement de facture classique confèrent à cette gamme un caractère dynamique et authentique.

The CLASSIC BORDELAISE design ingeniously enlivens the generic Bordeaux silhouette while preserving its great practicality. Tall, sleek outline, generous dimensions, and a classically crafted shoulder give this range a dynamic and authentic character.

CLASSIC BORDELAISE

STANDARD PREMIUM



Contenance Capacity	37,5 cl 12.68 oz	37,5 cl 12.68 oz	37,5 cl 12.68 oz	50 cl 16.91 oz
Référence Reference	3887	3887	3451	3599
Bague Finish	 Plate Unique	 Plate FA	 BVS 30H60	 Plate FA
Poids Weight	400 g 14.11 oz	400 g 14.11 oz	377 g 13.30 oz	500 g 17.64 oz
Hauteur totale [A] Overall height	260 mm 10.24 in	258 mm 10.16 in	259 mm 10.20 in	298,5 mm 11.75 in
Diamètre Corps [B] Body diameter	61,3 mm 2.41 in	61,3 mm 2.41 in	61 mm 2.40 in	64,9 mm 2.56 in
Diamètre de débouchage [C] Entrance bore diameter	18,5 mm 0.73 in	18,5 mm 0.73 in	20 mm 0.79 in	18,5 mm 0.73 in
Teinte Glass color	● Antique Antique Green ○ Extra Blanc Extra White Flint	● Antique* Antique Green ○ Extra Blanc Extra White Flint	● Antique Antique Green ○ Extra Blanc Extra White Flint	● Antique Antique Green ○ Extra Blanc Extra White Flint



50 cl 16.91 oz	75 cl 25.36 oz	75 cl 25.36 oz	75 cl 25.36 oz
3599	6512	6512	2987*
 Plate Unique	 Plate Unique	 Plate FA	 BVS 30H60
500 g 17.64 oz	602 g 21.23 oz	602 g 21.23 oz	707 g 24.94 oz
300,5 mm 11.83 in	320 mm 12.60 in	318 mm 12.52 in	321,3 mm 12.65 in
64,9 mm 2.56 in	74,5 mm 2.93 in	74,5 mm 2.93 in	75,6 mm 2.98 in
18,5 mm 0.73 in	18,5 mm 0.73 in	18,5 mm 0.73 in	20 mm 0.79 in
● Antique Antique Green ○ Extra Blanc Extra White Flint	● Antique Antique Green	● Antique Antique Green	● Antique Antique Green ○ Extra Blanc Extra White Flint

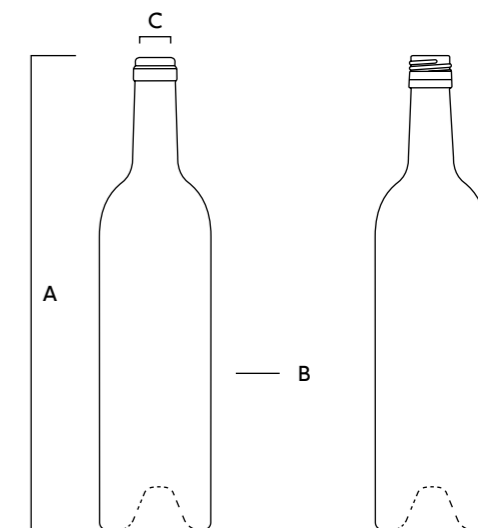

*: Sur commande Made to order

BORDELAISES PREMIÈRE

STANDARD PREMIUM



PREMIÈRE s'inspire directement du profil de la Bordelaise pour mieux s'en affranchir. Caractérisée par un trait vif et agile, sa silhouette légèrement conique exprime une modernité certaine. Le modèle bénéficie d'une gamme très large proposant un grand choix de contenances et une vaste palette de teintes et de bagues.

PREMIERE is directly inspired by the Bordelaise profile to make the best impression. Characterized by a lively agile outline, its slightly tapered silhouette expresses a certain modernity. The model offers the benefit of a very wide choice of containers and an extensive pallet of colors and finishes.



PREMIÈRE



PREMIÈRE



PREMIÈRE



PREMIÈRE

Contenance Capacity	37,5 cl 12.68 oz	50 cl 16.91 oz	75 cl 25.36 oz	75 cl 25.36 oz
Référence Reference	1806	2171	1735	1735
Bague Finish	 Plate Unique	 Plate Unique	 Plate Unique	 Plate FA
Poids Weight	410 g 14.46 oz	500 g 17.64 oz	715 g 25.22 oz	723 g 25.50 oz
Hauteur totale [A] Overall height	272,5 mm 10.73 in	289,3 mm 11.39 in	329,5 mm 12.97 in	327,5 mm 12.89 in
Diamètre Pied [B] Base diameter	56,6 mm 2.23 in	63 mm 2.48 in	72,1 mm 2.84 in	72,1 mm 2.84 in
Diamètre Épaule [C] Shoulder diameter	62,1 mm 2.44 in	68,2 mm 2.69 in	78,1 mm 3.07 in	78,1 mm 3.07 in
Diamètre de débouchage [D] Entrance bore diameter	18,5 mm 0.73 in	18,5 mm 0.73 in	18,5 mm 0.73 in	18,5 mm 0.73 in
Teinte Glass color	● Antique Antique Green ○ Extra Blanc Extra White Flint	● Antique Antique Green ○ Extra Blanc Extra White Flint	● Antique Antique Green ○ Extra Blanc Extra White Flint	● Antique Antique Green ○ Extra Blanc Extra White Flint



PREMIÈRE BVS



PREMIÈRE



PREMIÈRE

Contenance Capacity	75 cl 25.36 oz	150 cl 50.73 oz	300 cl 101.45 oz
Référence Reference	3221	1805	3222
Bague Finish	 BVS 30H60	 Carrée Spéciale	 Plate
Poids Weight	715 g 25.22 oz	1155 g 40.74 oz	1710 g 60.32 oz
Hauteur totale [A] Overall height	329,5 mm 12.97 in	399 mm 15.71 in	478 mm 18.82 in
Diamètre Pied [B] Base diameter	71,9 mm 2.83 in	89,5 mm 3.52 in	112,1 mm 4.41 in
Diamètre Épaule [C] Shoulder diameter	77,9 mm 3.07 in	97,5 mm 3.84 in	121,1 mm 4.77 in
Diamètre de débouchage [D] Entrance bore diameter	20 mm 0.79 in	18,5 mm 0.73 in	24 mm 0.94 in
Teinte Glass color	● Antique Antique Green ○ Extra Blanc* Extra White Flint	● Antique Antique Green ○ Extra Blanc Extra White Flint	● Antique Antique Green ○ Extra Blanc Extra White Flint

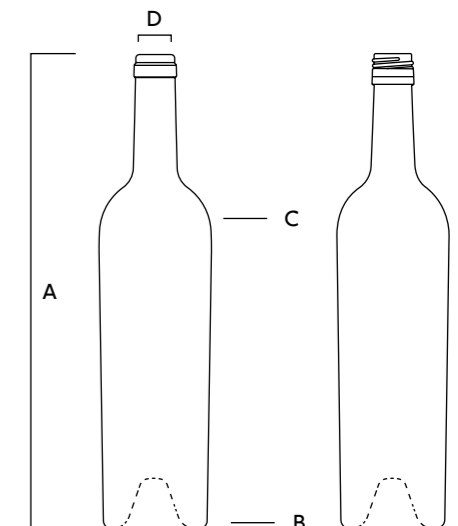

*: Sur commande Made to order

BORDELAISE SANTIAGO

STANDARD PREMIUM



SANTIAGO réveille la silhouette bordelaise en proposant une interprétation plus accessible des modèles traditionnels. Son élégance s'exprime au travers d'un corps cylindrique élancé – une hauteur de 325 mm – une épaule arrondie, un col fuselé surmonté d'une bague plate unique, pour un poids de 560 g.

SANTIAGO enlivens the Bordelaise silhouette by offering a more affordable interpretation of the traditional models. Its elegance is evident in its sleek cylindrical body – 325mm high – a rounded shoulder, tapered neck topped by a unique flat finish, and all weighing just 560g.



Contenance
Capacity

75 cl
25.36 oz

Référence
Reference

4565

Bague
Finish



Plate Unique

Poids
Weight

560 g
19.75 oz

Hauteur
totale [A]
Overall
height

325 mm
12.80 in

Diamètre
Corps [B]
Body
diameter

74,2 mm
2.92 in

Diamètre de
débouchage
[C] Entrance
bore diameter

18,5 mm
0.73 in

Teinte
Glass color

● Antique
Antique Green
○ Extra Blanc
Extra White Flint

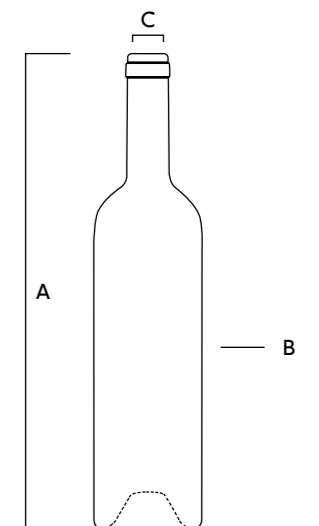

BORDELAISES TRADITION

STANDARD PREMIUM



La Bordelaise TRAD. PREMIUM délivre une interprétation contemporaine de la Bordelaise TRADITION. Préservant les caractéristiques dimensionnelles du modèle original, ce flacon se distingue notamment par une piqûre parée d'une boudine et par un rayon de jable nerveux très actuel. Une offre si complète en termes de contenances et de teintes de verre qu'elle s'apparente presque à une mission de Service Public! Du Magnum 1,5 litre à l'Impériale 6 litres, du verre Antique à la teinte Champagne, en passant par le verre Extra-Blanc ...

The Bordelaise TRAD. PREMIUM delivers a contemporary interpretation of the Bordelaise TRADITION. With the same dimensional characteristics as the original, this bottle stands out mainly by its punt with a "boudine" and a very modern racy heel diameter. The range is comprehensive in terms of size and glass colour. From the 1.5 litre Magnum to the imperial 6 litres, from Antique Green to Champagne Green and Extra-White Flint glass...

BORDELAISES TRADITION

STANDARD PREMIUM



	TRAD. PREMIUM	TRAD. PREMIUM	TRAD. PREMIUM BVS	TRADITION
Contenance Capacity	37,5 cl 12.68 oz	75 cl 25.36 oz	75 cl 25.36 oz	150 cl 50.73 oz
Référence Reference	4558	4427	4559	0099
Bague Finish	 Plate Unique	 Plate Unique	 BVS 30H60	 Carrée
Poids Weight	300 g 10.58 oz	550 g 19.40 oz	566 g 19.96 oz	1050 g 37.04 oz
Hauteur totale [A] Overall height	237,5 mm 9.35 in	300,5 mm 11.83 in	300,5 mm 11.83 in	357 mm 14.06 in
Diamètre Pied [B] Base diameter	- -	- -	- -	- -
Diamètre Épaule [C] Shoulder diameter	- -	- -	- -	- -
Diamètre Corps [D] Body diameter	61,6 mm 2.43 in	76,6 mm 3.02 in	76,6 mm 3.02 in	99,2 mm 3.91 in
Diamètre de débouchage [E] Entrance bore diameter	18,5 mm 0.73 in	18,5 mm 0.73 in	20 mm 0.79 in	18,5 mm 0.73 in
Teinte Glass color	● Antique Antique Green	● Antique Antique Green ○ Extra Blanc Extra White Flint	● Antique Antique Green ○ Extra Blanc Extra White Flint	● Antique Antique Green ○ Extra Blanc Extra White Flint



	TRAD. PREMIUM	TRAD. PREMIUM	TRADITION	TRADITION	TRADITION
Contenance Capacity	150 cl 50.73 oz	150 cl 50.73 oz	300 cl 101.45 oz	500 cl 169.09 oz	600 cl 202.91 oz
Référence Reference	4655	4692*	1434	0711	0714
Bague Finish	 Plate Unique	 BVS 30H60	 Plate	 Plate	 Plate
Poids Weight	1040 g 36.68 oz	1057 g 37.28 oz	1630 g 57.50 oz	2985 g 105.29 oz	3120 g 110.05 oz
Hauteur totale [A] Overall height	356 mm 14.02 in	357 mm 14.06 in	417,5 mm 16.44 in	466 mm 18.35 in	492,8 mm 19.40 in
Diamètre Pied [B] Base diameter	- -	- -	- -	152,7 mm 6.01 in	156,5 mm 6.16 in
Diamètre Épaule [C] Shoulder diameter	- -	- -	- -	157 mm 6.18 in	164,5 mm 6.48 in
Diamètre Corps [D] Body diameter	99 mm 3.90 in	99,4 mm 3.91 in	127,3 mm 5.01 in	- -	- -
Diamètre de débouchage [E] Entrance bore diameter	18,5 mm 0.73 in	20 mm 0.79 in	24 mm 0.94 in	31,5 mm 1.24 in	31,5 mm 1.24 in
Teinte Glass color	● Antique Antique Green	● Antique Antique Green	● Antique Antique Green ○ Extra Blanc Extra White Flint ● Champagne Champagne Green	● Champagne Champagne Green	● Champagne Champagne Green

*: Sur commande Made to order

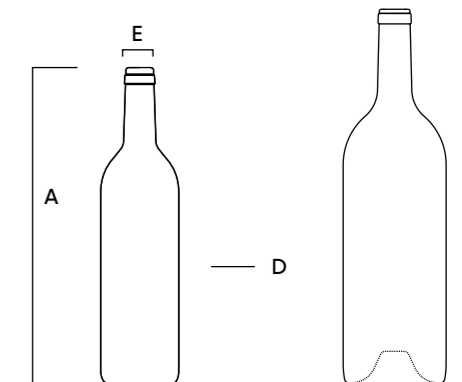

BORDELAISES PERSONNALISÉES



En complément des versions standard «lisses», certains de nos modèles sont proposés dans une version «PERSONNALISABLE» au moyen d'un médaillon gravé à l'épaule. Cette formule raffinée d'écussonnage s'avère extrêmement fidèle en terme de rendu verre de la gravure et particulièrement économique en terme de frais de développement.

In addition to the standard "smooth" versions, some of our models are offered in a "CUSTOMIZABLE" version in the form of an engraved locket on the shoulder. This refined approach, capitalizing on the quality of the design, is extremely efficient in terms of glass use and offers very economical development costs.



PREMIERE ÉCUSSONNÉE



CHÂTEAU ÉCUSSONNÉE



TRAD PREMIUM ÉCUSSONNÉE

Contenance Capacity	75 cl 25.36 oz	75 cl 25.36 oz	75 cl 25.36 oz
Référence Reference	2295*	2039*	5411*
Bague Finish	 Plate Unique	 Plate Unique	 Plate Unique
Poids Weight	715 g 25.22 oz	605 g 21.34 oz	565 g 19.93 oz
Hauteur totale [A] Overall height	329,5 mm 12.97 in	303 mm 11.93 in	300,5 mm 11.83 in
Diamètre Pied [B] Base diameter	72,1 mm 2.84 in	74,4 mm 2.93 in	76,6 mm 3.01 in
Diamètre Épaule [C] Shoulder diameter	78,1 mm 3.07 in	79,4 mm 3.13 in	76,6 mm 3.01 in
Diamètre de débouchage [D] Entrance bore diameter	18,5 mm 0.73 in	18,5 mm 0.73 in	18,5 mm 0.73 in
Teinte Glass color	● Antique Antique Green	● Antique Antique Green	● Antique Antique Green

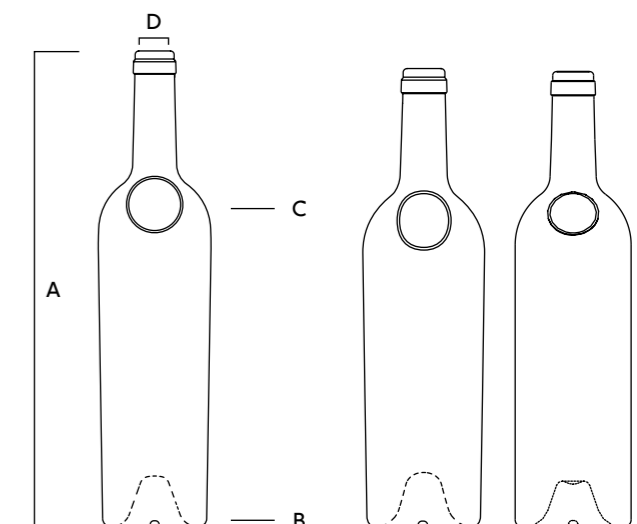

* : Sur commande Made to order

BORDELAISES BVS



Adaptée aux vins de garde comme aux vins plus jeunes, la capsule à vis offre une étanchéité parfaite, préservant, de fait, le produit des diverses altérations et notamment du risque de goût de bouchon. Respectant les qualités du vin, la bague à vis répond en outre aux nouvelles exigences de commodité des consommateurs. Saverglass propose aujourd'hui une gamme élargie de modèles équipés en bagues à vis, une collection qui s'inscrit dans la démarche de design, de différenciation et de premiumisation initiée depuis longtemps par le groupe Saverglass.

Suitable for young wines as well as those meant for cellaring, the screw cap offers a secure seal, preserving and protecting wines from the numerous problems that impact such a fragile product – including cork taint. By respecting a wine's qualities, screw caps meet the new demands of an expanding market. Saverglass now offers a broader screw finish line, a new twist on the tradition of design, differentiation and premium packaging that have long been the hallmark of the Saverglass Group.



Contenance Capacity	75 cl 25.36 oz	75 cl 25.36 oz	37,5 cl 12.68 oz	75 cl 25.36 oz	75 cl 25.36 oz
Référence Reference	3407	4518	3451	2987	5858
Bague Finish	 BVS 30H60	 BVS 31,5H60	 BVS 30H60	 BVS 30H60	 BVS 30H60
Poids Weight	615 g 21.69 oz	600 g 21.16 oz	377 g 13.30 oz	707 g 24.94 oz	610 g 21.52 oz
Hauteur totale [A] Overall height	299 mm 11.77 in	300 mm 11.81 in	259 mm 10.20 in	321,3 mm 12.65 in	318 mm 12.52 in
Diamètre Pied [B] Base diameter	74,1 mm 2.92 in	- -	- -	- -	71,4 mm 2.81 in
Diamètre Épaule [C] Shoulder diameter	81,4 mm 3.20 in	- -	- -	- -	77,3 mm 3.04 in
Diamètre Corps [D] Body diameter	- -	77,4 mm 3.05 in	61 mm 2.40 in	75,6 mm 2.98 in	- -
Diamètre de débouchage [E] Entrance bore diameter	20 mm 0.79 in	20 mm 0.79 in	20 mm 0.79 in	20 mm 0.79 in	20 mm 0.79 in

Teinte Glass color	● Antique Antique Green	● Antique Antique Green ○ Extra Blanc* Extra White Flint	● Antique Antique Green ○ Extra Blanc Extra White Flint	● Antique Antique Green ○ Extra Blanc* Extra White Flint	○ Extra Blanc Extra White Flint
-----------------------	----------------------------	---	--	---	------------------------------------

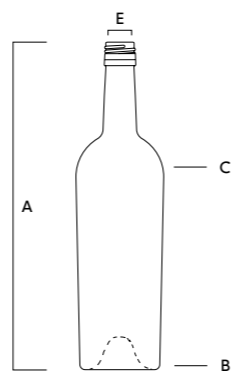

75 cl 25.36 oz	75 cl 25.36 oz	25 cl 8.45 oz	75 cl 25.36 oz	75 cl 25.36 oz	75 cl 25.36 oz	75 cl 25.36 oz	150 cl 50.73 oz
4048	6380	3751*	3753	3221	3832*	4559	4692*
 BVS 31,5H60	 BVS 31,5H60	 BVP 25H43	 BVS 30H60	 BVS 30H60	 BVS 31,5H60	 BVS 30H60	 BVS 30H60
998 g 35.20 oz	768 g 27.09 oz	280 g 9.88 oz	706 g 24.90 oz	715 g 25.22 oz	780 g 27.51 oz	566 g 19.96 oz	1057 g 37.28 oz
312,3 mm 12.30 in	308 mm 12.13 in	216,5 mm 8.52 in	320 mm 12.60 in	329,5 mm 12.97 in	312 mm 12.18 in	300,5 mm 11.83 in	357 mm 14.06 in
77,8 mm 3.06 in	75,6 mm 2.98 in	54,5 mm 2.15 in	75,9 mm 2.99 in	71,9 mm 2.83 in	- -	- -	- -
86,3 mm 3.40 in	81,8 mm 3.22 in	54,5 mm 2.15 in	75,9 mm 2.99 in	77,9 mm 3.07 in	- -	- -	- -
- -	- -	52,7 mm 2.07 in	72,9 mm 2.87 in	- -	78,9 mm 3.11 in	76,6 mm 3.02 in	99,4 mm 3.91 in
20 mm 0.79 in	20 mm 0.79 in	16,5 mm 0.65 in	20 mm 0.79 in	20 mm 0.79 in	20,5 mm 0.81 in	20 mm 0.79 in	20 mm 0.79 in

● Antique Antique Green	● Antique Antique Green	● Antique Antique Green ○ Extra Blanc Extra White Flint	○ Extra Blanc Extra White Flint	● Antique Antique Green ○ Extra Blanc* Extra White Flint	● Antique Antique Green	● Antique Antique Green ○ Extra Blanc Extra White Flint	● Antique Antique Green
----------------------------	----------------------------	--	------------------------------------	---	----------------------------	--	----------------------------

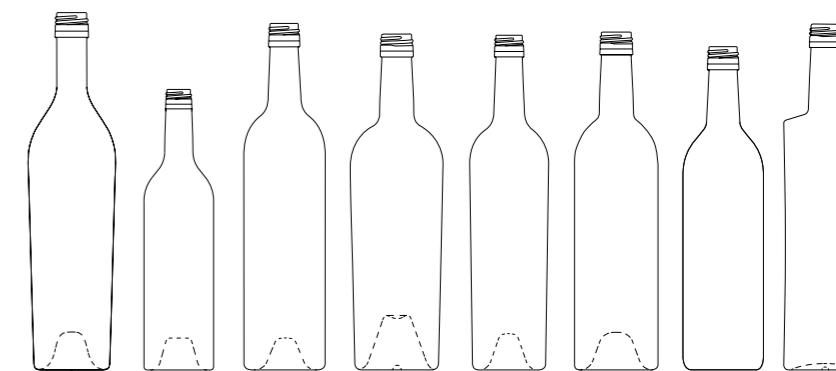

*: Sur commande Made to order

BOU RGO GN ES

BURGUNDY SHAPES

BOURGOGNE 1859

EXTRA PREMIUM



Authentique «bouteille d'époque», la Bourgogne 1859 reproduit la forme originelle de la bouteille bourguignonne. Mêmes proportions généreuses, mêmes épaules légèrement asymétriques, même type de bague, et surtout même profil de piqûre très profonde au plan de pose étroit et lisse, la Bourgogne 1859 reprend scrupuleusement toutes ces caractéristiques. Seule concession fonctionnelle par rapport à la forme originelle, celle de la hauteur du col: plus long et plus cylindrique, ce profil de col améliore la qualité du bouchage et facilite l'utilisation de longs bouchons comme l'exigent les vins de longue garde.

An authentic "vintage bottle", the Bourgogne 1859 reproduces the original shape of the Burgundy bottle. The same generous proportions, the same slightly asymmetric shoulders, same type of finish, and above all the same very deep punt with slim smooth line – the Bourgogne 1859 scrupulously retains all these characteristics. The only functional concession in terms of the original shape is the height of the neck: longer and more cylindrical, this neck shape improves the quality of corking and makes it easier to use long corks for wines that require a long aging time.



BOURGOGNE 1859



BOURGOGNE 1859 À CRAN
WITH NOTCH



BOURGOGNE 1859



BOURGOGNE 1859

Contenance Capacity	75 cl 25.36 oz	75 cl 25.36 oz	150 cl 50.73 oz	150 cl 50.73 oz
Référence Reference	3977	3977*	5301	5064
Bague Finish	 Carrée Chardonnay 32,8	 Carrée Chardonnay 32,8	 Carrée Bourgogne Classique	 Carrée Bourgogne Classique
Poids Weight	842 g 29.70 oz	842 g 29.70 oz	1540 g 54.32 oz	1490 g 52.56 oz
Hauteur totale [A] Overall height	303 mm 11.93 in	303 mm 11.93 in	367,4 mm 14.46 in	367,4 mm 14.46 in
Diamètre Corps [B] Body diameter	92,9 mm 3.66 in	92,9 mm 3.66 in	116,6 mm 4.59 in	115,9 mm 4.56 in
Diamètre de débouchage [C] Entrance bore diameter	18,5 mm 0.73 in	18,5 mm 0.73 in	18,5 mm 0.73 in	18,5 mm 0.73 in
Teinte Glass color	● Antique Antique Green ○ Extra Blanc Extra White Flint	● Antique Antique Green ○ Extra Blanc Extra White Flint	● Antique Antique Green	○ Extra Blanc Extra White Flint

* : Sur commande Made to order
Modèle déposé « Design Saverglass »
Registered "Design Saverglass"

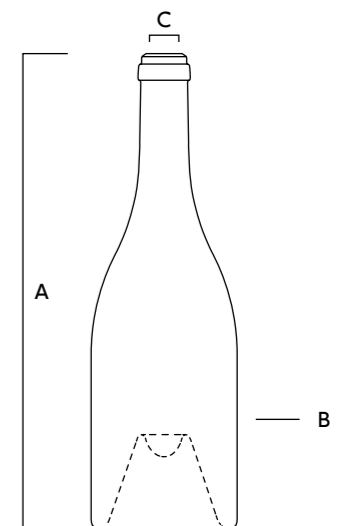

BOURGOGNE CRU CLASSÉ

EXTRA PREMIUM



En combinant un col très long, une piqûre majestueuse de 58 mm, une très légère conicité et une hauteur statutaire, la BOURGOGNE CRU CLASSÉ revisite avec justesse les canons bourguignons de l'époque. Mais c'est par un diamètre de corps imposant et une épaule marquée et généreuse que cette nouvelle silhouette affirme sa modernité, dévoilant une allure conquérante d'une grande élégance.

Combining a statutory height with a very long neck, a remarkable punt of 58mm and an ever-so-slight taper, the BOURGOGNE CRU CLASSÉ authentically revisits the Burgundy wines of the period. However, its substantial body diameter and distinct broad shoulder betray its modern-day influences, unveiling a bold appearance that exudes great elegance.



Contenance
Capacity

75 cl
25.36 oz

Référence
Reference

6100

Bague
Finish



Carrée Bourgogne Classique

Poids
Weight

822 g
28.99 oz

Hauteur
totale [A]
Overall
height

300 mm
11.81 in

Diamètre
Pied [B]
Base
diameter

91,4 mm
3.60 in

Diamètre
Épaule [C]
Shoulder
diameter

94,3 mm
3.71 in

Diamètre de
débouchage
[D] Entrance
bore diameter

18,5 mm
0.75 in

Teinte
Glass color

● Antique
Antique Green
○ Extra Blanc
Extra White Flint

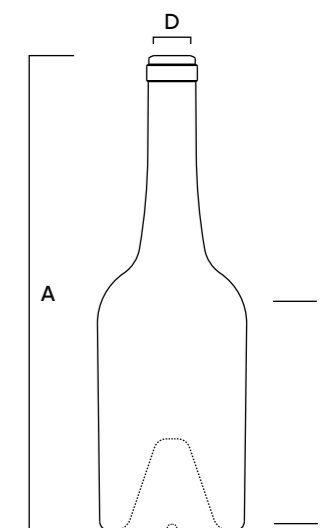

BOURGOGNE LA BARONNE

EXTRA PREMIUM



Fidèle réplique des Bourguignonnes d'antan, LA BARONNE déploie sans compromis les signes aristocratiques hérités de sa haute lignée: une stature de diva, un poids très confortable, une piqûre impressionnante, une épaule asymétrique qui participe au caractère « antique » du modèle.

A faithful reproduction of Burgundy wine bottles from yesteryear, LA BARONNE reveals, without any compromise, the aristocratic hallmarks of its lineage: the silhouette of a diva, a very comfortable weight, an impressive punt, an asymmetrical shoulder, all of which bestow on this bottle an "antique" character.



Contenance
Capacity

75 cl
25.36 oz

75 cl
25.36 oz

Référence
Reference

2770

4044*

Bague
Finish



Plate Déformée
Deformed cork mouth



BVS 31,5H60

Poids
Weight

950 g
33.51 oz

960 g
33.86 oz

Hauteur
totale [A]
Overall
height

305 mm
12.01 in

305 mm
12.01 in

Diamètre
Corps [B]
Body
diameter

92,4 mm
3.64 in

92 mm
3.62 in

Diamètre de
débouchage
[C] Entrance
bore diameter

18,5 mm
0.73 in

20 mm
0.79 in

Teinte
Glass color

● Antique
Antique Green

● Antique
Antique Green

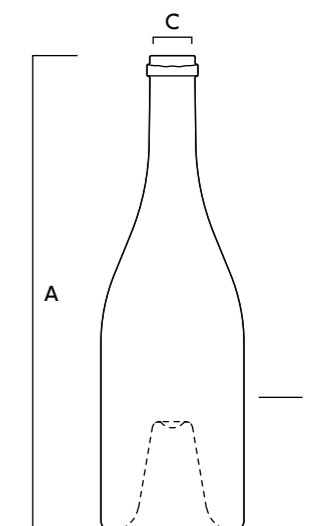

* : Sur commande Made to order
Modèle déposé « Design Saverglass »
Registered "Design Saverglass"

BOURGOGNE LA DIVINE

EXTRA PREMIUM



Créée pour révéler la prestance exceptionnelle et la noblesse des plus grands vins, LA DIVINE est dotée de magnifiques atours: elle captive par son port altier et sa silhouette aristocratique et bénéficie d'un poids généreux, d'une piqure très profonde.

Created to showcase the exceptional poise and nobility of the greatest wines, LA DIVINE has magnificent features: it is captivating in its majestic stature, its aristocratic silhouette and its heavy weight with a very deep punt.



Contenance
Capacity

75 cl
25.36 oz

Référence
Reference

3219

Bague
Finish



Carrée Bourgogne Classique

Poids
Weight

1005 g
35.45 oz

Hauteur
totale [A]
Overall
height

308,9 mm
12.16 in

Diamètre
Corps [B]
Body
diameter

92 mm
3.62 in

Diamètre de
débouchage
[C] Entrance
bore diameter

18,5 mm
0.73 in

Teinte
Glass color

● Antique
Antique Green

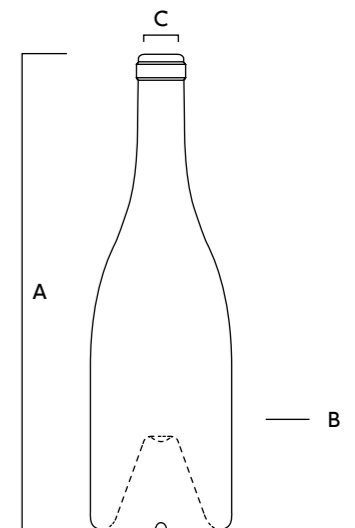

BOURGOGNE TERROIR





EXTRA PREMIUM



Jouant subtilement avec les codes traditionnels, la BOURGOGNE TERROIR présente une forte personnalité qui exprime pleinement toute la typicité des vins de terroir. Sa silhouette, inspirée des anciennes bouteilles régionales, est d'ailleurs reconnaissable entre toutes: un col long et gracile pour une manipulation aisée, une piqure haute de forme carrée de 53 mm, des épaules marquées et un corps cylindrique massif. A cela s'ajoute un large plan de pose identitaire qui enracine littéralement la bouteille dans le sol, comme pour affirmer sa filiation avec les vignobles.

Subtly playing with classic styles, THE BOURGOGNE TERROIR boasts a distinct identity that fully conveys the quintessential characteristics of "terroir" wines. Inspired by vintage bottles from the region, its silhouette is certainly eye-catching: a long, sleek neck for easy handling, a deep, square-shaped punt of 53mm, distinct shoulders, and a large cylindrical body. Added to that is a large cylindrical body. Added to that is a large cylindrical body. Added to that is a large cylindrical body.



Contenance Capacity	75 cl 25.36 oz	75 cl 25.36 oz	75 cl 25.36 oz	150 cl 50.73 oz
Référence Reference	6042	6042*	6042*	6421
Bague Finish	 Carrée Bourgogne Classique	 Lotus	 Double Cordon	 Carrée Bourgogne Classique
Poids Weight	880 g 31.04 oz	880 g 31.04 oz	870 g 30.69 oz	1700 g 59.96 oz
Hauteur totale [A] Overall height	293,8 mm 11.57 in	292,4 mm 12.51 in	291,3 mm 11.47 in	355,9 mm 14.01 in
Diamètre Corps [B] Body diameter	99,6 mm 3.92 in	99,6 mm 3.92 in	99,6 mm 3.92 in	124,8 mm 4.91 in
Diamètre de débouchage [C] Entrance bore diameter	18,5 mm 0.73 in	18,5 mm 0.73 in	18,5 mm 0.73 in	18,5 mm 0.73 in
Teinte Glass color	● Antique Antique Green ○ Extra Blanc Extra White Flint	● Antique Antique Green ○ Extra Blanc Extra White Flint	● Antique Antique Green ○ Extra Blanc Extra White Flint	● Antique Antique Green ○ Extra Blanc Extra White Flint

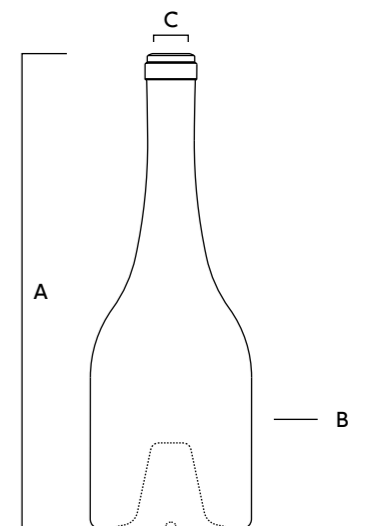

* : Sur commande Made to order
Modèle déposé « Design Saverglass »
Registered "Design Saverglass"

BOURGOGNE BOURGEOISE



SUPER PREMIUM



À la manière d'un classique revisité, le modèle BOURGEOISE possède tous les atouts pour valoriser des vins fins et authentiques. Il combine harmonieusement une haute stature, une bague cordon et une ligne inédite et élancée. Sa ligne inédite et élancée, son poids généreux, sa bague Plate sont autant de privilèges qui justifient son nom. Ses atouts valorisent la qualité et l'authenticité de votre vin.

In the manner of a revisited classic, the BOURGEOISE has all the features to showcase fine and authentic wines. It harmoniously combines tall stature, a Cordon finish and a strikingly sleek outline. A combination of features: generous glass weight, an innovative slender profile and a plate finish, justify the name. The bottle virtues underline the quality of your wine.



Contenance Capacity	75 cl 25.36 oz	75 cl 25.36 oz	75 cl 25.36 oz
Référence Reference	1847	1847	1847*
Bague Finish	 Cordon	 Plate FA	 Plate Unique
Poids Weight	783 g 27.62 oz	785 g 27.69 oz	785 g 27.69 oz
Hauteur totale [A] Overall height	322,7 mm 12.70 in	324,7 mm 12.78 in	326,7 mm 12.86 in
Diamètre Corps [B] Body diameter	85 mm 3.35 in	85 mm 3.35 in	85 mm 3.35 in
Diamètre de débouchage [C] Entrance bore diameter	18,5 mm 0.73 in	18,5 mm 0.73 in	17,5 mm 0.69 in
Teinte Glass color	● Antique Antique Green	● Antique Antique Green ○ Extra Blanc Extra White Flint	● Antique Antique Green

* : Sur commande Made to order
Modèle déposé « Design Saverglass »
Registered "Design Saverglass"

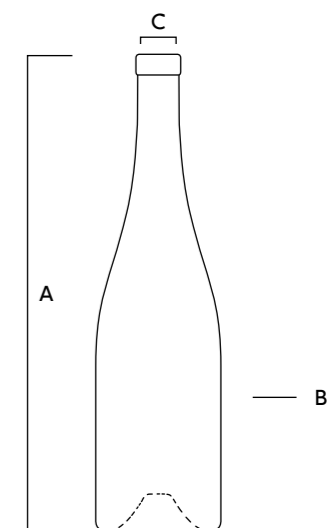

BOURGOGNE DIANE

SUPER PREMIUM



DIANE, fait rare pour une Bourguignonne, brille quant à elle par sa haute stature et par une silhouette gracile, qui lui assure une excellente visibilité en points de vente ou sur une table.

DIANE, rare for a Burgundy, stands out due to its tall, graceful silhouette, which guarantees it excellent visibility in-store or on a table.



Contenance
Capacity

75 cl
25.36 oz

Référence
Reference

3556

Bague
Finish



Plate Unique

Poids
Weight

810 g
28.57 oz

Hauteur
totale [A]
Overall
height

311,5 mm
12.26 in

Diamètre
Corps [B]
Body
diameter

88,9 mm
3.50 in

Diamètre de
débouchage
[C] Entrance
bore diameter

18,5 mm
0.73 in

Teinte
Glass color

● Antique
Antique Green

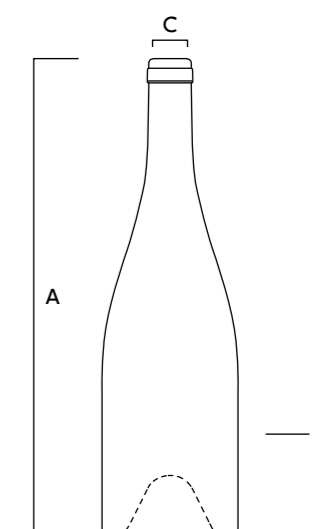

BOURGOGNE MARQUISE

SUPER PREMIUM



La BOURGOGNE MARQUISE donne instantanément une impression de force par ses formes pleines et harmonieuses inspirées des bouteilles bourguignonnes d'antan. Tout est ici affaire de mesure et de valeurs sûres: un poids de verre raisonnable prenant en compte les exigences d'un design responsable, un long col cylindrique, une épaule ample et une piqûre profonde dotée d'une boudine.

The BOURGOGNE MARQUISE gives an instant impression of strength with its full and harmonious forms inspired by Burgundy bottles from another era. The concept here is that of moderation and of true values: a reasonable glass weight taking into account the requirements of responsible design, a long cylindrical neck, a generous shoulder and a deep punt with a with an indented bulb — a tactile pearl of glass nestled in the punt of the bottle.



Contenance
Capacity

75 cl
25.36 oz

75 cl
25.36 oz

Référence
Reference

4374

4374*

Bague
Finish



Carrée Bourgogne

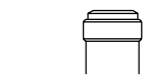

Carrée Chardonnay 32,8

Poids
Weight

800 g
28.22 oz

800 g
28.22 oz

Hauteur
totale [A]
Overall
height

285 mm
11.22 in

285,4 mm
11.24 in

Diamètre
Corps [B]
Body
diameter

92,4 mm
3.64 in

92,4 mm
3.64 in

Diamètre de
débouchage
[C] Entrance
bore diameter

18,5 mm
0.73 in

18,5 mm
0.73 in

Teinte
Glass color

● Antique
Antique Green
○ Extra Blanc
Extra White Flint

● Antique
Antique Green
○ Extra Blanc
Extra White Flint

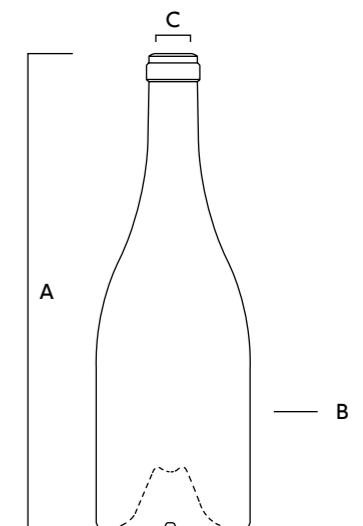

* : Sur commande Made to order
Modèle déposé « Design Saverglass »
Registered "Design Saverglass"

BOURGOGNE MAXIMA

SUPER PREMIUM



Le modèle MAXIMA puise son style unique et élancé, particulièrement élégant, au travers de son épaulement placé spécialement bas et l'exceptionnelle longueur gracile de son col. Ce modèle révèle un design résolument moderne, ergonomique, et donc idéalement adapté aux manipulations bourguignonnes classiques.

MAXIMA draws its unique, sleek, particularly elegant style from its distinctively low shoulder and its exceptionally long graceful neck. This model reveals a proudly modern, ergonomic design ideally suited to traditional burgundy handling.

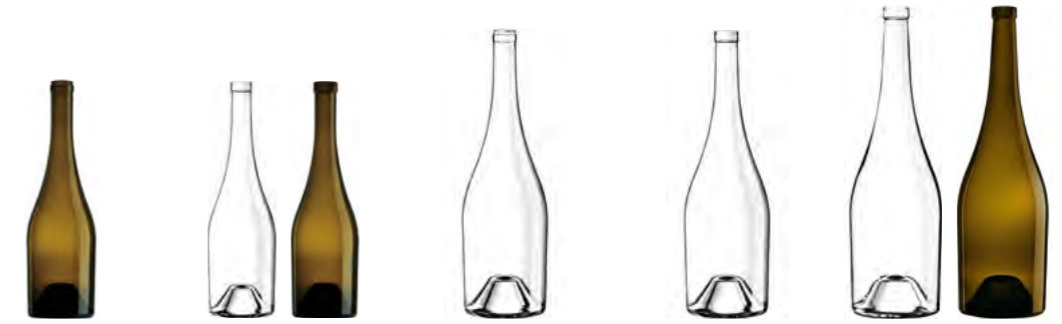

Contenance Capacity	75 cl 25.36 oz	75 cl 25.36 oz	150 cl 50.73 oz	150 cl 50.73 oz	300 cl 101.45 oz
Référence Reference	4979	4979	5189*	5189	5208
Bague Finish	 Carrée Bourgogne Classique	 Plate FA	 Carrée Bourgogne Classique	 Plate FA	 Plate FA
Poids Weight	815 g 28.75 oz	815 g 28.75 oz	1282 g 45.22 oz	1280 g 45.15 oz	2150 g 75.84 oz
Hauteur totale [A] Overall height	315 mm 12.40 in	312,6 mm 12.31 in	382,4 mm 15.06 in	380 mm 14.96 in	474,9 mm 18.70 in
Diamètre Pied [B] Base diameter	88,4 mm 3.48 in	88,4 mm 3.48 in	109,7 mm 4.32 in	109,7 mm 4.32 in	135,6 mm 5.34 in
Diamètre Épaule [C] Shoulder diameter	93,1 mm 3.67 in	93,1 mm 3.67 in	115,6 mm 4.55 in	115,6 mm 4.55 in	143 mm 5.63 in
Diamètre de débouchage [D] Entrance bore diameter	18,5 mm 0.73 in	18,5 mm 0.73 in	18,5 mm 0.73 in	18,5 mm 0.73 in	24 mm 0.94 in
Teinte Glass color	● Antique Antique Green	● Antique Antique Green ○ Extra Blanc Extra White Flint	● Antique Antique Green ○ Extra Blanc Extra White Flint	● Antique Antique Green ○ Extra Blanc Extra White Flint	● Antique* Antique Green ○ Extra Blanc Extra White Flint

* : Sur commande Made to order
Modèle déposé « Design Saverglass »
Registered "Design Saverglass"

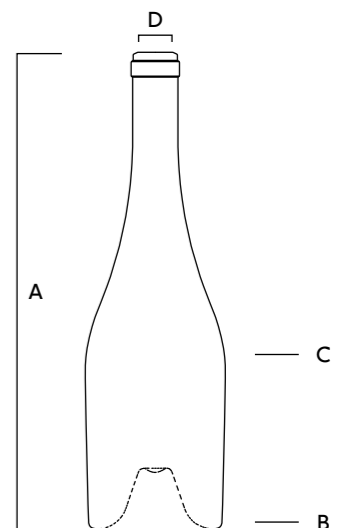

BOURGOGNE SABINE

SUPER PREMIUM



SABINE déploie des courbes fluides et ultra-féminines dans un style sans cesse renouvelé au gré des différents types de bagues proposées. Stylée, innovante et contemporaine, la gamme SABINE siéra avec perfection aux vins de cépages, aux rosés (dans sa version Extra-Blanc) ou aux vins du Nouveau Monde.

SABINE offers flowing ultra-feminine curves in a continuously renewed style by using different types of finishes. Stylish, innovative and contemporary, the SABINE range is perfect for vintage wines, rosé wines (in its Extra White version), and New World wines.



Contenance
Capacity

75 cl
25.36 oz

75 cl
25.36 oz

Référence
Reference

2638

2638

Bague
Finish

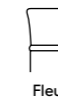

Fleur

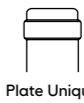

Plate Unique

Poids
Weight

720 g
25.40 oz

700 g
24.69 oz

Hauteur
totale [A]
Overall
height

319 mm
12.56 in

306,3 mm
12.06 in

Diamètre
Pied [B]
Base
diameter

77,5 mm
3.05 in

77,5 mm
3.05 in

Diamètre
Épaule [C]
Shoulder
diameter

93,3 mm
3.67 in

93,3 mm
3.67 in

Diamètre de
débouchage
[D] Entrance
bore diameter

18,5 mm
0.73 in

18,5 mm
0.73 in

Teinte
Glass color

● Antique
Antique Green
○ Extra Blanc
Extra White Flint

● Antique*
Antique Green
○ Extra Blanc
Extra White Flint

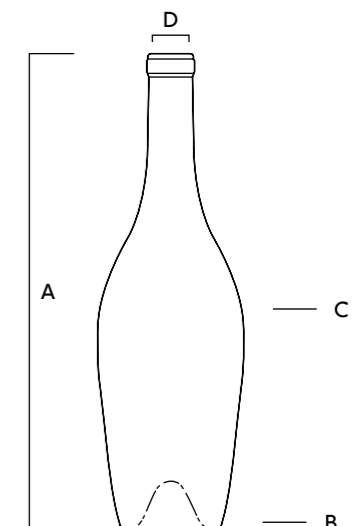

* : Sur commande Made to order
Modèle déposé « Design Saverglass »
Registered "Design Saverglass"

BOURGOGNE ATLAS

PREMIUM +



La bouteille ATLAS BVS se positionne comme la bourguignonne la plus distinguée et la plus contemporaine des modèles de la gamme munis de la bague à vis la plus diffusée, à savoir la «BVS 30H60». La bouteille offre une belle silhouette équilibrée et élancée, une épaule fluide et un rayon bas-fût très nerveux. Tous ces détails lui confèrent un caractère empreint de pure élégance et de sobre modernité.

The BVS ATLAS bottle is the most distinguished and contemporary design of the range with the widely used screw finish, "BVS 30H60". The bottle has an attractive balanced and streamlined silhouette, a flowing shoulder and a very spirited lower-body radius. All these details give it a character imbued with pure elegance, practicality and modernity.



Contenance
Capacity

75 cl
25.36 oz

Référence
Reference

3618

Bague
Finish



BVS 30H60

Poids
Weight

820 g
28.92 oz

Hauteur
totale [A]
Overall
height

310 mm
12.20 in

Diamètre
Corps [B]
Body
diameter

89 mm
3.50 in

Diamètre de
débouchage
[C] Entrance
bore diameter

19 mm
0.75 in

Teinte
Glass color

● Antique
Antique Green

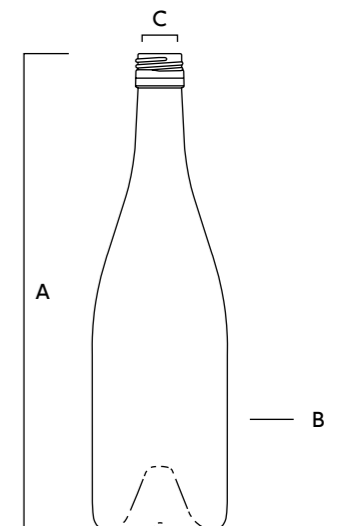

BOURGOGNE CÉLESTE

PREMIUM +



Charismatique, la Bourgogne CÉLESTE séduit par ses attributs uniques : une hauteur de 300 mm qui la distingue de la forme bourgogne classique, une piqûre profonde de 40 mm parée d'une boudine, une bague carrée bourgogne et enfin, un poids de verre raisonnable de 750 g. Combinant avec habileté classicisme et authenticité, la Bourgogne CÉLESTE propose ainsi un modèle de grande facture dédié aux grands crus et conforme à une exploitation sur ligne aisée.

Charismatic, the Bourgogne CELESTE offers a seductive range of features including its 300mm height, which distinguishes it from the classic Burgundy shape, a deep 40mm punt with a "boudine"(a tactile pearl of glass nestled in the punt of the bottle), a square Burgundy finish and a very reasonable 750g glass weight. Smoothly combining classic and authentic, the Bourgogne CÉLESTE offers meticulous craftsmanship dedicated to great vintages and well suited to production line operation.



Contenance
Capacity

75 cl
25.36 oz

Référence
Reference

5357

Bague
Finish



Carrée Bourgogne

Poids
Weight

757 g
26.70 oz

Hauteur
totale [A]
Overall
height

300 mm
11.81 in

Diamètre
Corps [B]
Body
diameter

89 mm
3.50 in

Diamètre de
débouchage
[C] Entrance
bore diameter

18,5 mm
0.73 in

Teinte
Glass color

● Antique
Antique Green

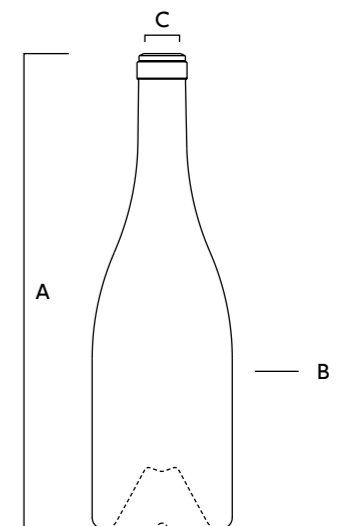

BOURGOGNE CHARDONNAY

PREMIUM +



CHARDONNAY emprunte son nom à l'un des cépages les plus réputés au monde. Associant classicisme et authenticité, ce modèle impose son fort tempérament en s'appuyant notamment sur une belle bague carrée. Résolument moderne, la version BVS 31.5H60 reste extrêmement fonctionnelle.

CHARDONNAY takes its name from one of the most famous grapes in the world. Combining classic style and authenticity, this model stands out with its strong temperament displayed in its beautiful square finish. Although proudly modern, the BVS 31.5H60 version remains extremely functional.



Contenance Capacity	75 cl 25.36 oz	75 cl 25.36 oz	75 cl 25.36 oz
Référence Reference	2315	2315	4133
Bague Finish	 Carrée Chardonnay	 Carrée Bourgogne	 BVS 31.5H60
Poids Weight	850 g 29.98 oz	850 g 29.98 oz	865 g 30.51 oz
Hauteur totale [A] Overall height	306 mm 12.05 in	305,6 mm 12.03 in	306 mm 12.05 in
Diamètre Corps [B] Body diameter	86,6 mm 3.41 in	86,6 mm 3.41 in	86,6 mm 3.41 in
Diamètre de débouchage [C] Entrance bore diameter	18,5 mm 0.73 in	18,5 mm 0.73 in	20 mm 0.79 in
Teinte Glass color	● Antique Antique Green	● Antique Antique Green	● Antique Antique Green

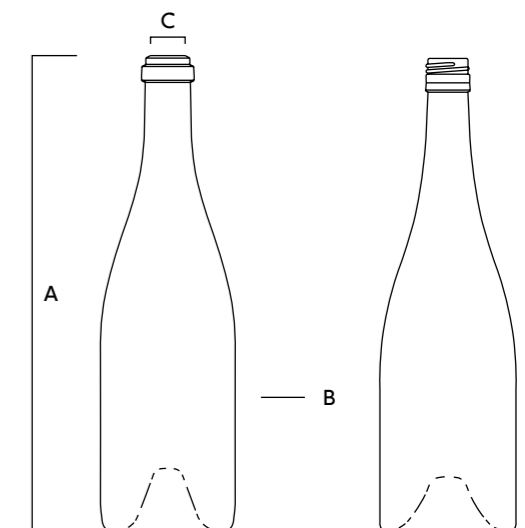

Modèle déposé « Design Saverglass »
Registered "Design Saverglass"

BOURGOGNE TASTEVINE ET SYNERGY

PREMIUM +



TASTEVINE emprunte son nom au vocabulaire des confrères bachiques. Ses contours harmonieux jouent l'accord parfait entre un fût à la forme délicatement conique, des épaules galbées prolongées par un long col insufflant à l'ensemble une touche de légèreté.

TASTEVINE takes its name from the wine-tasting fraternity. The harmony of its shape with its subtly tapered body and rounded shoulders extending into a long neck, imbue the bottle with a touch of lightness.





TASTEVINE



MAGNUM
TASTEVINE



SYNERGY

Contenance Capacity	75 cl 25.36 oz	150 cl 50.73 oz	300 cl 101.45 oz
Référence Reference	2296**	3386**	5790
Bague Finish	 Plate Unique	 Carrée Spéciale	 Plate Bordelaise
Poids Weight	675 g 23.81 oz	1150 g 40.56 oz	1800 g 63.49 oz
Hauteur totale [A] Overall height	300 mm 11.81 in	360 mm 14.17 in	446,5 mm 17.58 in
Diamètre Pied [B] Base diameter	83,8 mm 3.30 in	105 mm 4.13 in	130,5 mm 5.14 in
Diamètre Épaule [C] Shoulder diameter	89,3 mm 3.52 in	114,5 mm 4.51 in	139,5 mm 5.49 in
Diamètre de débouchage [D] Entrance bore diameter	18,5 mm 0.73 in	18,5 mm 0.73 in	24 mm 0.94 in
Teinte Glass color	● Antique Antique Green ○ Extra Blanc Extra White Flint	● Antique Antique Green ○ Extra Blanc Extra White Flint	● Antique* Antique Green ○ Extra Blanc Extra White Flint

*: Sur commande Made to order
**: Modèle déposé « Design Saverglass »
Registered "Design Saverglass"

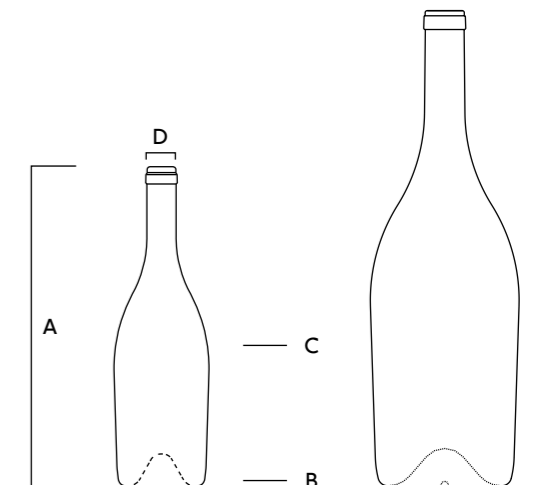

BOURGOGNE VIN GRAND CRU

PREMIUM +



Les bouteilles de la gamme VIN GRAND CRU se sont naturellement imposées comme des conditionnements d'exception grâce à leur silhouette caractéristique : un corps trapu et une épaule tombante que prolonge un col exceptionnellement long s'étirant à « l'infini ». Un design soigné et merveilleusement intemporel destiné à sublimer le vin.

Bottles in the VIN GRAND CRU range epitomize luxury with their characteristic silhouette: short wide bodies with elegant sloping shoulders to accentuate the unusually long necks stretching upward to infinity. This delicate and marvelously timeless design will enhance any wine.



Contenance Capacity	75 cl 25.36 oz	75 cl 25.36 oz	75 cl 25.36 oz	150 cl 50.73 oz
Référence Reference	0604*	0604*	0604	2404
Bague Finish	 Flange	 Plate FA	 Plate Unique	 Carrée
Poids Weight	678 g 23.92 oz	685 g 24.16 oz	685 g 24.16 oz	1170 g 41.27 oz
Hauteur totale [A] Overall height	284,4 mm 11.20 in	292 mm 11.50 in	293,5 mm 11.56 in	360 mm 14.17 in
Diamètre Pied [B] Base diameter	91,7 mm 3.61 in	91,7 mm 3.61 in	91,7 mm 3.61 in	114,6 mm 4.51 in
Diamètre Épaule [C] Shoulder diameter	92,7 mm 3.65 in	92,7 mm 3.65 in	92,7 mm 3.65 in	115,8 mm 4.56 in
Diamètre de débouchage [D] Entrance bore diameter	18,5 mm 0.73 in	18,5 mm 0.73 in	18,5 mm 0.73 in	21 mm 0.83 in
Teinte Glass color	● Antique Antique Green	● Antique Antique Green	● Antique Antique Green	● Antique Antique Green

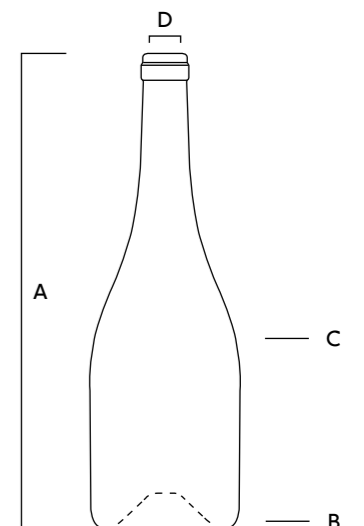

* : Sur commande Made to order
Modèle déposé « Design Saverglass »
Registered "Design Saverglass"

BOURGOGNE AGAPE

PREMIUM



La Bourgogne AGAPE affiche une version moderne de la silhouette bourguignonne. Un corps cylindrique, une bague carrée bourgogne et une piqûre distinctive constituent un ensemble idéalement rythmé, dessiné dans le souci du détail et d'une grande praticité.

The Bourgogne AGAPE offers a modern version of the traditional Burgundian style. A cylindrical body, a carrée bourgogne finish and a distinctive punt offer an optimally balanced ensemble, designed with attention to detail and full functionality.



Contenance Capacity	75 cl 25.36 oz	150 cl 50.73 oz
Référence Reference	5065	5760
Bague Finish	 Carrée Bourgogne	 Carrée Bourgogne
Poids Weight	700 g 24.69 oz	1250 g 44.09 oz
Hauteur totale [A] Overall height	296,1 mm 11.66 in	368,1 mm 14.49 in
Diamètre Corps [B] Body diameter	88,7 mm 3.49 in	111,7 mm 4.40 in
Diamètre de débouchage [C] Entrance bore diameter	18,5 mm 0.73 in	18,5 mm 0.73 in
Teinte Glass color	● Antique Antique Green ○ Extra Blanc Extra White Flint	● Antique Antique Green ○ Extra Blanc Extra White Flint

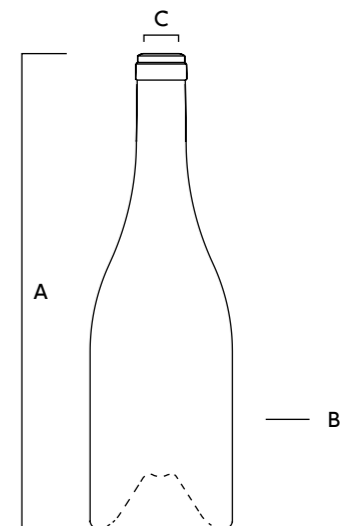

*: Sur commande Made to order

BOURGOGNE AMARANTE



PREMIUM



Une silhouette unique au travers de son épaulement bas couplé à son long col gracile. AMARANTE révèle un design optimisé en terme de poids de verre (597 gr seulement), résolument moderne, ergonomique, et donc idéalement adapté aux manipulations classiques des vignerons.

A unique silhouette through its low shoulder coupled with its long graceful neck. AMARANTE reveals a design optimized in terms of glass weight (only 597gr), resolutely modern, ergonomic, and therefore ideally adapted to the classic handling of winegrowers.



Contenance Capacity	75 cl 25.36 oz	75 cl 25.36 oz	150 cl 50.73 oz
Référence Reference	6331	6331*	6619
Bague Finish	 Plate FA	 Plate Unique	 Plate FA
Poids Weight	597 g 21.06 oz	597 g 21.06 oz	1000 g 35.27 oz
Hauteur totale [A] Overall height	312,4 mm 12.30 in	310,4 mm 12.22 in	381,9 mm 15.04 in
Diamètre Pied [B] Base diameter	86,3 mm 3.40 in	86,3 mm 3.40 in	108,1 mm 4.26 in
Diamètre Épaule [C] Shoulder diameter	90,3 mm 3.56 in	90,3 mm 3.56 in	112,1 mm 4.41 in
Diamètre de débouchage [D] Entrance bore diameter	18,5 mm 0.73 in	18,5 mm 0.73 in	18,5 mm 0.73 in
Teinte Glass color	● Antique* Antique Green ○ Extra Blanc Extra White Flint	● Antique Antique Green ○ Extra Blanc Extra White Flint	○ Extra Blanc Extra White Flint

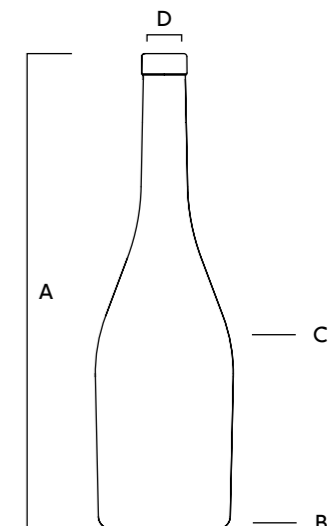

* : Sur commande Made to order

BOURGOGNE CÉPAGE

STANDARD PREMIUM



L'élégante silhouette classique de son design permet à la gamme CÉPAGE de conjuguer fonctionnalité, grâce et distinction, soit autant de qualités qui répondent aux exigences des vins de garde.

The elegantly classic silhouette of the design of the CÉPAGE range combines functionality, grace and distinction, the essential qualities required for wines meant for cellaring.



Contenance Capacity	75 cl 25.36 oz	75 cl 25.36 oz	75 cl 25.36 oz
Référence Reference	1462	1462	1462*
Bague Finish	 Carrée Bourgogne	 Plate Unique	 Flange
Poids Weight	700 g 24.69 oz	700 g 24.69 oz	695 g 24.51 oz
Hauteur totale [A] Overall height	296 mm 11.65 in	295,6 mm 11.64 in	286,4 mm 11.28 in
Diamètre Corps [B] Body diameter	87,8 mm 3.46 in	87,8 mm 3.46 in	87,8 mm 3.46 in
Diamètre de débouchage [C] Entrance bore diameter	18,5 mm 0.73 in	18,5 mm 0.73 in	18,5 mm 0.73 in
Teinte Glass color	● Antique Antique Green	● Antique Antique Green	● Antique Antique Green

* : Sur commande Made to order
Modèle déposé « Design Saverglass »
Registered "Design Saverglass"

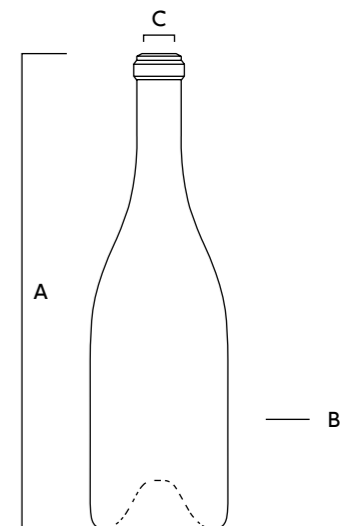

BOURGOGNE GRAVILLE

STANDARD PREMIUM



Référence dans la catégorie des Bourguignonnes Standard Premium, l'opulente GRAVILLE est reconnaissable entre toutes. On aime son épaule ample et galbée, son corps puissant et son jable prononcé.

Leading the way in the Standard Premium Burgundian category, the opulent GRAVILLE is immediately recognizable. It is prized for its full rounded shoulder, powerful body and pronounced heel.



Contenance
Capacity

75 cl
25.36 oz

Référence
Reference

T045

Bague
Finish



Plate Unique

Poids
Weight

655 g
23.10 oz

Hauteur
totale [A]
Overall
height

295 mm
11.61 in

Diamètre
Corps [B]
Body
diameter

88,6 mm
3.49 in

Diamètre de
débouchage
[C] Entrance
bore diameter

18,5 mm
0.73 in

Teinte
Glass color

● Antique
Antique Green

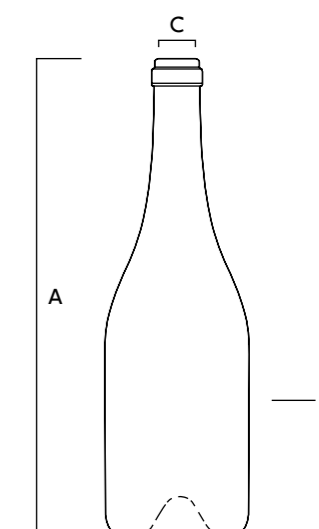

Modèle déposé « Design Saverglass »
Registered "Design Saverglass"

BOURGOGNE GRAND MILLÉSIME

STANDARD PREMIUM



Une version anoblie de la silhouette bourguignonne, et cependant respectueuse de la « Tradition »... Ses mensurations parfaites et ses options de bouchage (la bague classique cétie, la bague BVS ou l'impressionnante bague carrée spéciale) lui valent le titre envié de Bourgogne GRAND MILLESIME.

Incorporating the Burgundy shape yet emphasizing traditional values... The perfect proportions and range of available finishes (Cork finish, BVS screw cap or Special Square burgundy finish) truly justify the prestigious title of Bourgogne GRAND MILLESIME.



Contenance Capacity	75 cl 25.36 oz	75 cl 25.36 oz	75 cl 25.36 oz
Référence Reference	1825	1825*	2988
Bague Finish	 Plate Unique	 Carrée Bourgogne SP	 BVS 30H60
Poids Weight	650 g 22.93 oz	655 g 23.10 oz	700 g 24.69 oz
Hauteur totale [A] Overall height	293 mm 11.54 in	293,8 mm 11.57 in	303 mm 11.93 in
Diamètre Corps [B] Body diameter	85,5 mm 3.37 in	85,5 mm 3.37 in	85,5 mm 3.37 in
Diamètre de débouchage [C] Entrance bore diameter	18,5 mm 0.73 in	18,5 mm 0.73 in	20 mm 0.79 in
Teinte Glass color	● Antique Antique Green	● Antique Antique Green	● Antique Antique Green

* : Sur commande Made to order
Modèle déposé « Design Saverglass »
Registered "Design Saverglass"

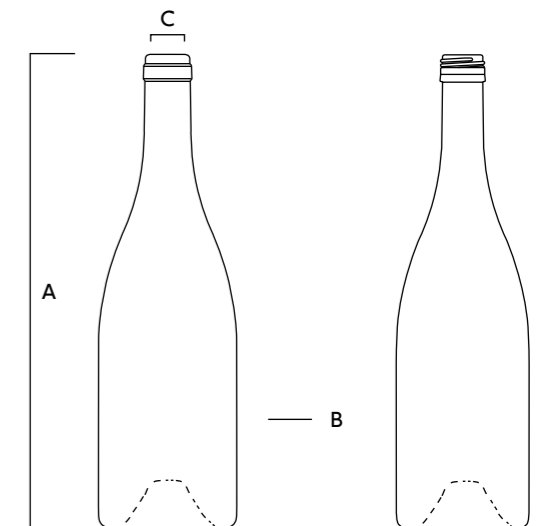

BOURGOGNE PRESTIGE

STANDARD PREMIUM



Les bouteilles de la gamme PRESTIGE subliment l'image des grands vins et préservent l'héritage de la traditionnelle silhouette bourguignonne en y insufflant modernité et sophistication.

Bottles in the PRESTIGE range enhance the image of great wines and preserve the heritage of the traditional Burgundian silhouette, imparting a modern and sophisticated style.



Contenance Capacity	37,5 cl 12.68 oz	37,5 cl 12.68 oz	50 cl 16.91 oz	50 cl 16.91 oz
Référence Reference	1893	3649	2158	4340
Bague Finish	 Plate Unique	 BVS 30H60	 Plate Unique	 BVS 30H60
Poids Weight	437 g 15.41 oz	437 g 15.41 oz	540 g 19.05 oz	540 g 19.05 oz
Hauteur totale [A] Overall height	232,5 mm 9.15 in	232,5 mm 9.15 in	258,8 mm 10.19 in	258,8 mm 10.19 in
Diamètre Corps [B] Body diameter	72 mm 2.83 in	72 mm 2.83 in	77,9 mm 3.07 in	77,6 mm 3.06 in
Diamètre de débouchage [C] Entrance bore diameter	18,5 mm 0.73 in	20,5 mm 0.81 in	18,5 mm 0.73 in	20 mm 0.79 in
Teinte Glass color	● Antique Antique Green	● Antique Antique Green	● Antique Antique Green ○ Extra Blanc Extra White Flint	● Antique Antique Green ○ Extra Blanc Extra White Flint

Modèle déposé « Design Saverglass »
Registered "Design Saverglass"

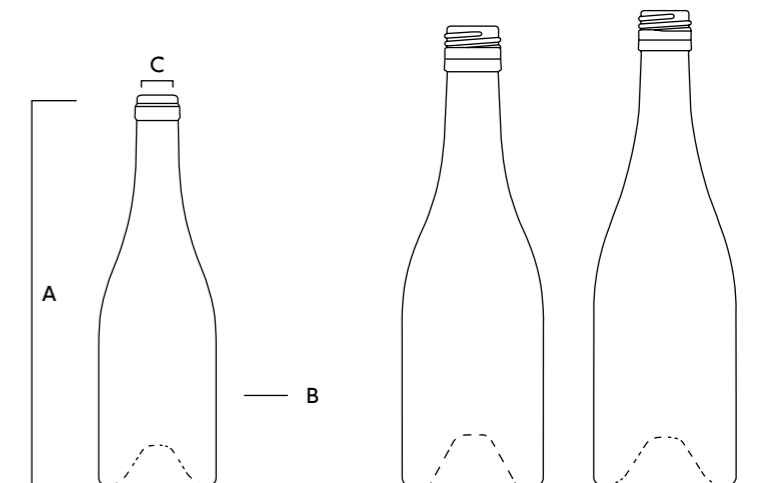

BOURGOGNES TRADITION

STANDARD PREMIUM



Fonctionnelle et idéalement équilibrée, la bouteille BOURGOGNE TRADITION propose un conditionnement sobre et élégant qui tient compte des exigences de la profession et utilise les grands standards de bouchage.

The BOURGOGNE TRADITION bottle is both functional and well balanced, offering a clean and elegant outline in harmony with the industry's demands and capping standards.

BOURGOGNES TRADITION

STANDARD PREMIUM



TRADITION



TRADITION



CLASSIQUE



CLASSIQUE BVS P

Contenance Capacity	75 cl 25.36 oz	75 cl 25.36 oz	75 cl 25.36 oz	75 cl 25.36 oz
Référence Reference	1824	4413	1746	4339*
Bague Finish	 Plate Unique	 BVS 30H60	 Carrée Bourgogne	 BVS 31.5H60
Poids Weight	600 g 21.16 oz	530 g 18.69 oz	600 g 21.16 oz	600 g 21.16 oz
Hauteur totale [A] Overall height	296 mm 11.65 in	295 mm 11.61 in	296,1 mm 11.66 in	296 mm 11.65 in
Diamètre Corps [B] Body diameter	82,2 mm 3.24 in	82,2 mm 3.24 in	82,4 mm 3.24 in	82,7 mm 3.26 in
Diamètre de débouchage [C] Entrance bore diameter	18,5 mm 0.73 in	20 mm 0.79 in	18,5 mm 0.73 in	20 mm 0.79 in
Teinte Glass color	● Antique Antique Green	● Antique Antique Green ○ Extra Blanc Extra White Flint	● Antique Antique Green	● Antique Antique Green



TRADITION



TRADITION



TRADITION



TRADITION BVS



TRADITION



TRADITION

150 cl 50.73 oz	150 cl 50.73 oz	150 cl 50.73 oz	150 cl 50.73 oz	300 cl 101.45 oz	500 cl 169.09 oz
1835	5311	1179	4833	1035	1036
 Plate Unique	 Carrée Bourgogne	 Carrée Bourgogne	 BVS 30H60	 Carrée	 Carrée
1100 g 38.80 oz	1000 g 35.27 oz	1158 g 40.85 oz	1076 g 37.95 oz	1530 g 53.97 oz	2700 g 95.24 oz
354,6 mm 13.96 in	354,6 mm 13.96 in	354,6 mm 13.96 in	354,6 mm 13.96 in	437,5 mm 17.22 in	495 mm 19.49 in
107,5 mm 4.23 in	106 mm 4.17 in	107,5 mm 4.23 in	107,5 mm 4.23 in	131,2 mm 5.17 in	160 mm 6.30 in
18,5 mm 0.73 in	18,5 mm 0.73 in	21 mm 0.83 in	19 mm 0.75 in	28 mm 1.10 in	28 mm 1.10 in
● Antique Antique Green	● Antique Antique Green	● Antique Antique Green	● Antique Antique Green	● Antique Antique Green	● Antique Antique Green
○ Extra Blanc Extra White Flint					
● Champagne* Champagne Green					

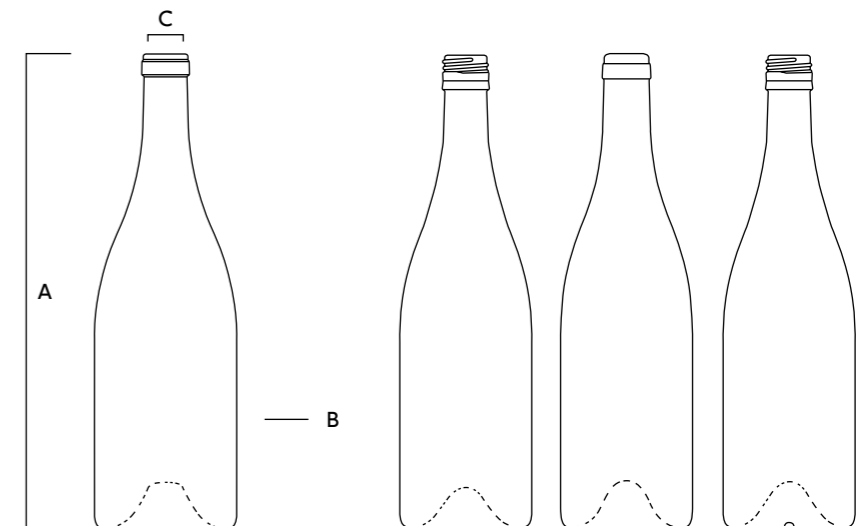

BOURGOGNES PERSONNALISÉES



En complément des versions standard «lisses», certains de nos modèles sont proposés dans une version «PERSONNALISABLE» au moyen d'un médaillon gravé à l'épaule. Cette formule raffinée d'écussonnage s'avère extrêmement fidèle au plan du rendu verre de la gravure et particulièrement économique en terme de frais de développement.

In addition to the standard "smooth" versions, some of our models are offered in a "CUSTOMIZABLE" version in the form of an engraved locket on the shoulder. This refined approach, capitalizing on the quality of the design, is extremely efficient in terms of glass use and offers very economical development costs.



CÉPAGE ÉCUSSONNÉE



CÉPAGE BAS-RELIEF



TASTEVINE ÉCUSSONNÉE

Contenance Capacity	75 cl 25.36 oz	75 cl 25.36 oz	75 cl 25.36 oz
Référence Reference	2105*	2708*	2793*
Bague Finish	 Plate Unique	 Plate Unique	 Plate Unique
Poids Weight	700 g 24.69 oz	690 g 24.34 oz	675 g 23.81 oz
Hauteur totale [A] Overall height	296 mm 11.65 in	295,5 mm 11.63 in	300 mm 11.81 in
Diamètre Pied [B] Base diameter	87,8 mm 3.46 in	87,8 mm 3.46 in	83,8 mm 3.30 in
Diamètre Épaule [C] Shoulder diameter	87,8 mm 3.46 in	87,8 mm 3.46 in	89,3 mm 3.51 in
Diamètre de débouchage [D] Entrance bore diameter	18,5 mm 0.73 in	18,5 mm 0.73 in	18,5 mm 0.73 in
Teinte Glass color	● Antique Antique Green	● Antique Antique Green	● Antique Antique Green

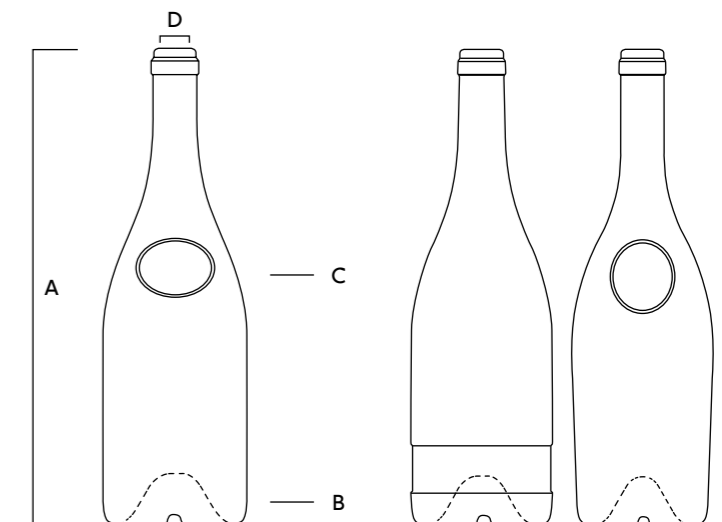

* : Sur commande Made to order
Modèle déposé « Design Saverglass »
Registered "Design Saverglass"

BOURGOGNES BVS



Fonctionnelles par leurs sages mensurations, attractives par leurs lignes équilibrées, les Bourgognes BVS prennent en compte les exigences d'aujourd'hui au travers de ce principe de bouchage.

The BVS Burgundian range is both functional with its dimensions, attractive with its well-balanced outline and in harmony with today's demands with its capping principle.



ATLAS BVS **ANTI-K BVS** **CHARDONNAY BVS** **CLASSIC BVS P**

Contenance Capacity	75 cl 25.36 oz	75 cl 25.36 oz	75 cl 25.36 oz	75 cl 25.36 oz
Référence Reference	3618	6385	4133	4339*
Bague Finish	 BVS 30H60	 BVS 30H60	 BVS 31,5H60	 BVS 31,5H60
Poids Weight	820 g 28.92 oz	641 g 22.61 oz	865 g 30.51 oz	600 g 21.16 oz
Hauteur totale [A] Overall height	310 mm 12.20 in	267 mm 10.51 in	306 mm 12.05 in	296 mm 11.65 in
Diamètre Pied [B] Base diameter	-	92,2 mm 3.63 in	-	-
Diamètre Épaule [C] Shoulder diameter	-	98,2 mm 3.87 in	-	-
Diamètre Corps [D] Body diameter	89 mm 3.50 in	-	86,6 mm 3.41 in	82,7 mm 3.26 in
Diamètre de débouchage [E] Entrance bore diameter	19 mm 0.75 in	20 mm 0.79 in	20 mm 0.79 in	20 mm 0.79 in

Teinte Glass color	● Antique Antique Green	● Antique Antique Green ○ Extra Blanc Extra White Flint	● Antique Antique Green	● Antique Antique Green
-----------------------	----------------------------	--	----------------------------	----------------------------

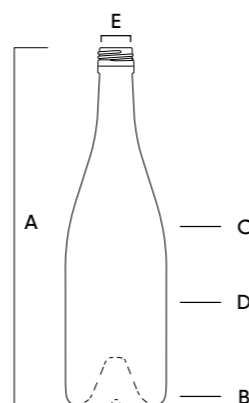

* : Sur commande Made to order



GRAND MILLÉSIME BVS **LA BARONNE BVS** **PRESTIGE BVS P** **PRESTIGE BVS P** **TRADITION BVS** **TRADITION BVS**

Contenance Capacity	75 cl 25.36 oz	75 cl 25.36 oz	37,5 cl 12.68 oz	50 cl 16.91 oz	75 cl 25.36 oz	150 cl 50.73 oz
Référence Reference	2988	4044*	3649	4340	4413	4833
Bague Finish	 BVS 30H60	 BVS 31,5H60	 BVS 30H60	 BVS 30H60	 BVS 30H60	 BVS 30H60
Poids Weight	700 g 24.69 oz	960 g 33.86 oz	437 g 15.41 oz	540 g 19.05 oz	530 g 18.69 oz	1076 g 37.95 oz
Hauteur totale [A] Overall height	303 mm 11.93 in	305 mm 12.01 in	232,5 mm 9.15 in	258,8 mm 10.19 in	295 mm 11.61 in	354,6 mm 13.96 in
Diamètre Pied [B] Base diameter	-	-	-	-	-	-
Diamètre Épaule [C] Shoulder diameter	-	-	-	-	-	-
Diamètre Corps [D] Body diameter	85,5 mm 3.37 in	92 mm 3.62 in	72 mm 2.83 in	77,6 mm 3.06 in	82,2 mm 3.24 in	107,5 mm 4.23 in
Diamètre de débouchage [E] Entrance bore diameter	20 mm 0.79 in	20 mm 0.79 in	20,5 mm 0.81 in	20 mm 0.79 in	20 mm 0.79 in	21 mm 0.83 in

Teinte Glass color	● Antique Antique Green	● Antique Antique Green	● Antique Antique Green	● Antique Antique Green ○ Extra Blanc Extra White Flint	● Antique Antique Green ○ Extra Blanc Extra White Flint	● Antique Antique Green
-----------------------	----------------------------	----------------------------	----------------------------	--	--	----------------------------

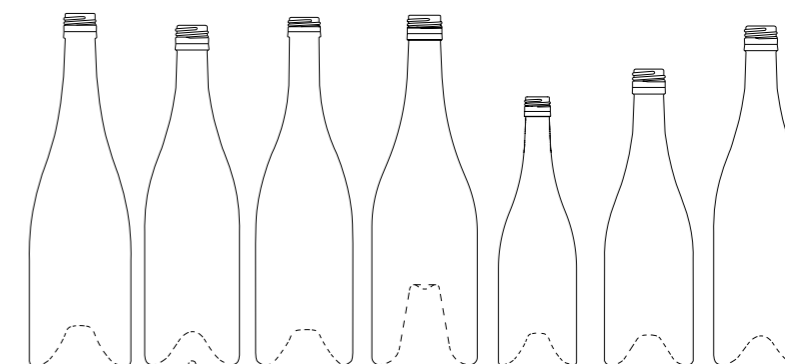

NOU VEAUX CON CEPTS

NEW CONCEPTS

NOUVEAUX CONCEPTS AIKIDO SUPER PREMIUM



Empruntant ses lignes affirmées à l'univers des spiritueux, AIKIDO revisite avec autant d'audace l'esprit du best-seller KENDO WINE. Dotée d'un corps légèrement conique, d'une épaule oblique, d'un pan coupé au niveau du bas-fût et d'une piqûre en pointe enverrée, AIKIDO signe ainsi la nouvelle référence avant-gardiste de l'univers du vin.

Borrowing its distinctive lines from the world of spirits, AIKIDO boldly revisits the style of the best-selling KENDO WINE. With its slightly conical body, the oblique shoulders, the truncated edge at the bottle base and a punt in pointed glass, AIKIDO is the new avant-garde benchmark in the world of wines.



Contenance
Capacity

75 cl
25.36 oz

Référence
Reference

5787

Bague
Finish

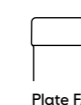

Poids
Weight

640 g
22.57 oz

Hauteur
totale [A]
Overall
height

319,5 mm
12.58 in

Diamètre
Pied [B]
Base
diameter

72,4 mm
2.85 in

Diamètre
Épaule [C]
Shoulder
diameter

76 mm
2.99 in

Diamètre de
débouchage
[D] Entrance
bore diameter

18,5 mm
0.75 in

Teinte
Glass color

○ Extra Blanc
Extra White Flint

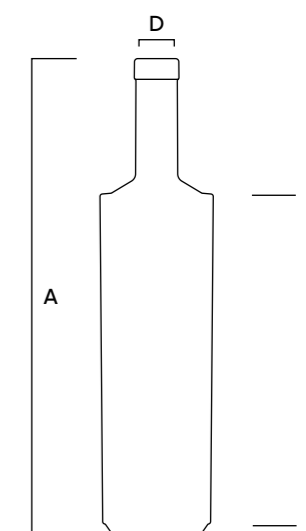

NOUVEAUX CONCEPTS ICARO WINE



SUPER PREMIUM



Une bouteille carrée? Assurément avant-gardiste, ICARO séduira une clientèle en quête de parti-pris stylistique, novateur et affirmé. Iconoclaste, ICARO relève avec audace le défi d'une bordelaise tout en conservant l'esprit du modèle originel, soit l'exemple parfait du classique revisité.

A square bottle? Proudly avant-garde, ICARO will entice a clientele looking for a stylish, novel and confident statement. The iconoclastic ICARO daringly tackles the Bordeaux challenge while retaining the spirit of the original model, as a perfect example of a revisited classic.



Contenance Capacity	50 cl 16.91 oz	75 cl 25.36 oz	150 cl 50.73 oz
Référence Reference	3598*	3536*	3866
Bague Finish	 Plate FA	 Plate FA	 Plate FA
Poids Weight	545 g 19.22 oz	723 g 25.50 oz	1200 g 42.33 oz
Hauteur totale [A] Overall height	300,5 mm 11.83 in	335 mm 13.19 in	397 mm 15.63 in
Diamètre Pied [B] Base diameter	60,8*60,8 mm 2.39 x 2.39 in	69,7*69,7 mm 2.74 x 2.74 in	88,4*88,4 mm 3.48 x 3.48 in
Diamètre Épaule [C] Shoulder diameter	63,8*63,8 mm 2.51 x 2.51 in	72,7*72,7 mm 2.86 x 2.86 in	92,2*92,2 mm 3.63 x 3.63 in
Diamètre de débouchage [D] Entrance bore diameter	18,5 mm 0.73 in	18,5 mm 0.73 in	18,5 mm 0.73 in
Teinte Glass color	● Antique Antique Green	● Antique Antique Green ○ Extra Blanc Extra White Flint	● Antique* Antique Green ○ Extra Blanc Extra White Flint

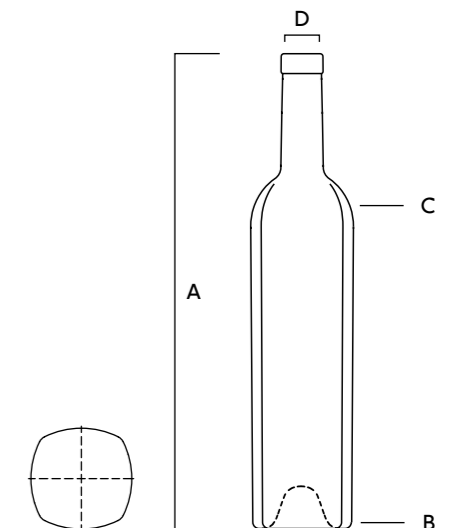

* : Sur commande Made to order
Modèle déposé « Design Saverglass »
Registered "Design Saverglass"

NOUVEAUX CONCEPTS

ESSENCIA WINE



SUPER PREMIUM



Le modèle ESSENCIA WINE dessine avec fraîcheur des contours fluides emprunts de modernité et de sensualité. Son bas-fût évasé stabilise une silhouette féminine aux traits vifs qui mêlent grâce et distinction.

ESSENCIA WINE brings a touch of -freshness to the fluid contours, which take their cues from a more modern and sensual source. Its flared base steadies a feminine silhouette of lofty energy that blends grace and distinction.



Contenance Capacity	75 cl 25.36 oz	150 cl 50.73 oz
Référence Reference	4852	5452*
Bague Finish	 Plate FA	 Plate FA
Poids Weight	700 g 24.69 oz	1180 g 41.62 oz
Hauteur totale [A] Overall height	329 mm 12.95 in	406 mm 15.98 in
Diamètre Pied [B] Base diameter	72,5 mm 2.85 in	101,5 mm 4.00 in
Diamètre Épaule [C] Shoulder diameter	81,4 mm 3.20 in	90,4 mm 3.56 in
Diamètre de débouchage [D] Entrance bore diameter	18,5 mm 0.73 in	18,5 mm 0.73 in
Teinte Glass color	● Antique Antique Green ○ Extra Blanc Extra White Flint	○ Extra Blanc Extra White Flint

* : Sur commande Made to order
Modèle déposé « Design Saverglass »
Registered "Design Saverglass"

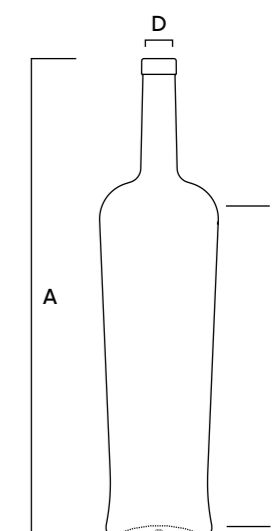

NOUVEAUX CONCEPTS FENG WINE

SUPER PREMIUM



Moins provocante que la silhouette KENDO, la forme du modèle FENG WINE offre des particularités esthétiques et fonctionnelles plus en rapport avec son unique vocation de bouteille de vin. Ses proportions plus académiques, son épaule plus oblique, son fût cylindrique et sa piqûre de profil carré inscrivent clairement la bouteille dans l'univers du vin, sans altérer pour autant la vivacité et la puissance de son design.

Less provocative than the KENDO silhouette, the shape of the FENG WINE exhibits aesthetic and functional characteristics which are in line with its use for wines. Its more conventional proportions, its slanted shoulder, its cylindrical body and its square punt, place the bottle unmistakably in the world of wines, without diminishing in any way the vivacity and the power of its design.



Contenance
Capacity

75 cl
25.36 oz

Référence
Reference

3781

Bague
Finish



Poids
Weight

710 g
25.04 oz

Hauteur
totale [A]
Overall
height

305 mm
12.01 in

Diamètre
Corps [B]
Body
diameter

77,4 mm
3.05 in

Diamètre de
débouchage
[C] Entrance
bore diameter

18,5 mm
0.73 in

Teinte
Glass color

● Antique
Antique Green
○ Extra Blanc
Extra White Flint

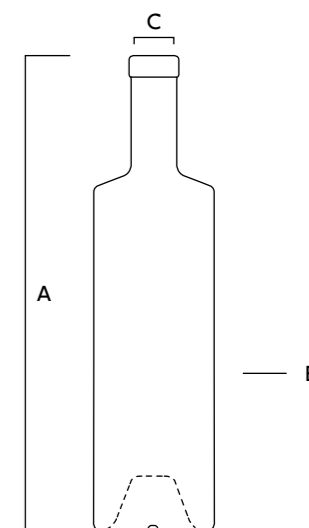

NOUVEAUX CONCEPTS ICON DUOMO

SUPER PREMIUM



Si l'on apprécie la Bordelaise ICON pour son élégance un brin aristocratique, on ne peut que succomber à cette variante qui renouvelle avec talent et justesse le style bordelais. DUOMO - que l'on devine, par son nom, inspirée des dômes flamboyants de la Renaissance italienne - réveille ainsi les lignes traditionnelles grâce à un épaule parée d'un magnifique jeu de rayures horizontales. A cette fantaisie tout en délicatesse s'oppose la sobriété du corps du flacon, idéalement adapté à une personnalisation via un décor ou une étiquette.

Whilst the Bordelaise ICON is admired for its almost aristocratic elegance, this new variant—which masterfully and faithfully reinvents the Bordeaux style—is irresistible. DUOMO—its name suggestive of the flamboyant domes of the Italian Renaissance—reawakens traditional lines with shoulders adorned with a magnificent set of horizontal stripes. This elegant vision is in contrast to the simplicity of the bottle's body, perfectly suited for customising with decorations or a label.



Contenance
Capacity

75 cl
25.36 oz

Référence
Reference

6660

Bague
Finish



Poids
Weight

774 g
27.30 oz

Hauteur
totale [A]
Overall
height

308,2 mm
12.13 in

Diamètre pied [B]
Base diameter

76,2 mm
3.00 in

Diamètre épaule [C]
Shoulder diameter

82,4 mm
3.24 in

Diamètre de
débouchage [D]
Entrance
bore diameter

18,5 mm
0.73 in

Teinte
Glass color

● Antique
Antique Green
○ Extra Blanc
Extra White Flint

Modèle déposé « Design Saverglass »
Registered "Design Saverglass"

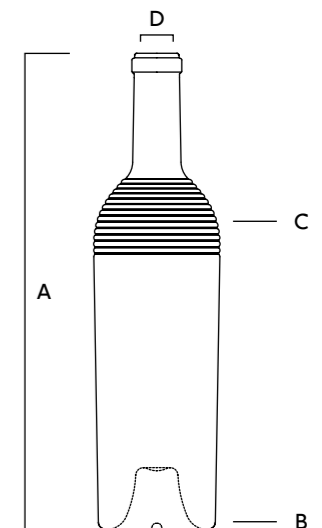

NOUVEAUX CONCEPTS INSOLENCE



SUPER PREMIUM



INSOLENCE affiche avec hardiesse une silhouette fluide, vivace et inventive. Dotée d'un fort tempérament, sa singularité réside dans sa forme conique inversée caractéristique et sa piqûre carrée unique, reconnaissable entre toutes. Impertinente, audacieuse et résolument moderne, INSOLENCE séduit par son élégance rare et un style affirmé.

The INSOLENCE bottle features robustness with a fluid, vivacious and inventive silhouette. The strong character of this line is emphasized by its unique inverted conical shape and its original squared punt that makes it stand out amongst all other forms. The impertinent, audacious and resolutely modern design of INSOLENCE impresses through its unusual elegance and distinctive style.



Contenance Capacity	75 cl 25.36 oz	75 cl 25.36 oz	150 cl 50.73 oz
Référence Reference	5786	5786*	5924
Bague Finish	 Plate FA	 Plate FA HT 22	 Plate FA
Poids Weight	641 g 22.61 oz	651 g 22.96 oz	1100 g 38.80 oz
Hauteur totale [A] Overall height	320 mm 12.60 in	328 mm 12.91 in	396,1 mm 15.59 in
Diamètre Pied [B] Base diameter	80 mm 3.15 in	80 mm 3.15 in	99,3 mm 3.91 in
Diamètre Épaule [C] Shoulder diameter	68,6 mm 2.70 in	68,6 mm 2.70 in	85 mm 3.35 in
Diamètre de débouchage [D] Entrance bore diameter	18,5 mm 0.73 in	18,5 mm 0.73 in	18,5 mm 0.73 in
Teinte Glass color	● Antique* Antique Green ○ Extra Blanc Extra White Flint	● Antique Antique Green ○ Extra Blanc Extra White Flint	● Antique* Antique Green ○ Extra Blanc Extra White Flint

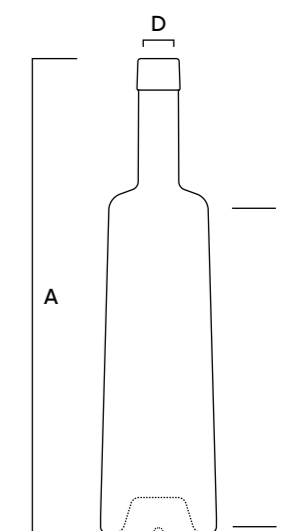

* : Sur commande Made to order
Modèle déposé « Design Saverglass »
Registered "Design Saverglass"

NOUVEAUX CONCEPTS

KENDO WINE



SUPER PREMIUM



Interprétation audacieuse et rupturiste de la forme bordelaise, KENDO WINE emprunte ses lignes graphiques à l'univers des spiritueux. Avec un léger cintrage du corps, des épaules vives et une semelle de verre plate, KENDO WINE signe une bouteille au design avant-gardiste dans le monde du vin. Innovante, cette bouteille offre des possibilités d'habillage et de bouchage inédits, et propose un écrin parfaitement adapté aux nouvelles tendances de consommation.

KENDO WINE is a bold interpretation that departs from the traditional Bordeaux design, borrowing its graphic lines from the world of liquor. Its slightly curved body, taut shoulders and a flat glass base give KENDO WINE a distinctive avant-garde shape in the winemaking industry. With its innovative profile, this bottle offers potentials for inventive presentation and closure, and paves the way for new consumer trends.



Contenance Capacity	25 cl 8.45 oz	75 cl 25.36 oz	75 cl 25.36 oz
Référence Reference	3751*	3340	3753
Bague Finish	 BVP 25H43	 Plate spirit	 BVS 30H60
Poids Weight	280 g 9.88 oz	740 g 26.10 oz	706 g 24.90 oz
Hauteur totale [A] Overall height	216,5 mm 8.52 in	320 mm 12.60 in	320 mm 12.60 in
Diamètre Pied [B] Base diameter	54,5 mm 2.15 in	76 mm 2.99 in	75,9 mm 2.99
Diamètre Épaule [C] Shoulder diameter	54,5 mm 2.15 in	76 mm 2.99 in	75,9 mm 2.99 in
Diamètre de débouchage [D] Entrance bore diameter	16,5 mm 0.65 in	18,5 mm 0.75 in	20 mm 0.79 in
Teinte Glass color	● Antique Antique Green ○ Extra Blanc Extra White Flint	● Antique Antique Green ○ Extra Blanc Extra White Flint	● Antique* Antique Green ○ Extra Blanc Extra White Flint

* : Sur commande Made to order
Modèle déposé « Design Saverglass »
Registered "Design Saverglass"

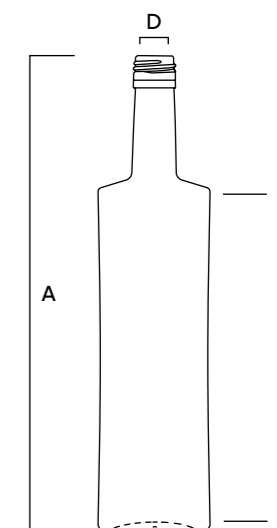

NOUVEAUX CONCEPTS MASSALIA

SUPER PREMIUM



À la fois sophistiquée et simplissime, innovante et évidente, dynamique et sensuelle, MASSALIA cultive à plaisir les contraires. Sa singularité réside dans sa forme conique inversée. Son élégance fluide résulte de sa belle stature et d'une parfaite justesse de proportions. Son caractère féminin est souligné par la rondeur de l'épaule et une espiègle piqûre en forme d'ogive.

Sophisticated yet extremely pure, innovative yet simple, dynamic yet sensuous, MASSALIA indulges itself in contradictions. Its uniqueness comes from its inverted tapered shape. Its flowing elegance comes from its attractive stature and its well-balanced proportions. Its feminine character is underlined by the roundness of its shoulder and a bullet shaped punt.



Contenance
Capacity

75 cl
25.36 oz

Référence
Reference

3776

Bague
Finish



Plate FA

Poids
Weight

715 g
25.22 oz

Hauteur
totale [A]
Overall
height

330 mm
12.99 in

Diamètre
Pied [B]
Base
diameter

83,4 mm
3.28 in

Diamètre
Épaule [C]
Shoulder
diameter

68,4 mm
2.69 in

Diamètre de
débouchage
[D] Entrance
bore diameter

18,5 mm
0.75 in

Teinte
Glass color

● Antique
Antique Green
○ Extra Blanc
Extra White Flint

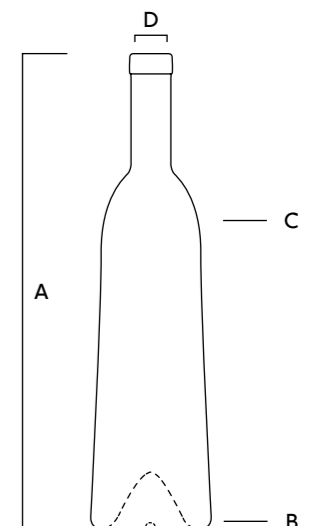

NOUVEAUX CONCEPTS POMPADOUR WINE

SUPER PREMIUM



Révélant une silhouette féminine et des courbes sensuelles, POMPADOUR WINE joue la carte du raffinement et de la séduction. Son corps rond et statuaire, sa piqûre haute avec boudine, ses belles proportions et son long col gracile dessinent un modèle d'une grande élégance.

Flaunting a feminine profile with sensual curves, POMPADOUR WINE exudes refinement and seduction. Its round and constitutional body, its deep punt featuring a "boudine", its beautiful proportions and its long slender neck make it a model of great elegance.



Contenance
Capacity

75 cl
25.36 oz

150 cl
50.73 oz

Référence
Reference

5777

6109

Bague
Finish

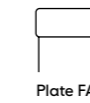

Plate FA

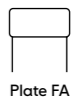

Plate FA

Poids
Weight

716 g
25.26 oz

1200 g
42.33 oz

Hauteur
totale [A]
Overall
height

310 mm
12.20 in

373,7 mm
14.71 in

Diamètre
Pied [B]
Base
diameter

80,5 mm
3.17 in

101 mm
3.98 in

Diamètre
Épaule [C]
Shoulder
diameter

98,5 mm
3.88 in

123,5 mm
4.86 in

Diamètre de
débouchage
[D] Entrance
bore diameter

18,5 mm
0.73 in

18,5 mm
0.73 in

Teinte
Glass color

● Antique
Antique Green
○ Extra Blanc
Extra White Flint

● Antique
Antique Green
○ Extra Blanc
Extra White Flint

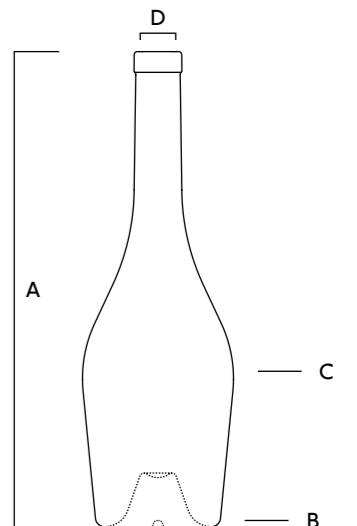

NOUVEAUX CONCEPTS SOLSTICE

SUPER PREMIUM



Réinterprétant l'ovale des cuves particulièrement plébiscitées en biodynamie, le concept SOLSTICE affirme un caractère fort. Ce corps aux courbes si singulières, allié à un long col fuselé et à un pan coupé au niveau du bas fût, imprime le flacon d'une indéniable prestance. Mais au-delà de cette esthétique résolument contemporaine, SOLSTICE intègre également une conception design plus technique: à l'instar des carafes à décanter, ce col effilé couplé à cette forme ovoïdale favorise en effet les échanges entre l'air et le vin.

Taking its inspiration from the ovoid-shaped tanks specifically chosen for use in biodynamic wine-making, SOLSTICE concept exudes a bold identity. The bottle is imbued with an unmistakable elegance through its uniquely curvaceous body coupled with a long, tapered neck and a truncated edge along the lower section. Beyond the decidedly modern aesthetics, however, SOLSTICE also incorporates a more practical design element – similar to decanters, the bottle's slender neck combined with its ovoid-shaped body effectively helps to aerate the wine.



SOLSTICE LUNE
DESCENDANTE

SOLSTICE LUNE
DESCENDANTE

SOLSTICE LUNE
MONTANTE

SOLSTICE LUNE
MONTANTE

Contenance Capacity	75 cl 25.36 oz	75 cl 25.36 oz	75 cl 25.36 oz	75 cl 25.36 oz
Référence Reference	6029	6029	6028	6028
Bague Finish	 Plate FA	 Cordon Wine	 Plate FA	 Cordon Wine
Poids Weight	690 g 24.34 oz	681 g 24.02 oz	690 g 24.34 oz	681 g 24.02 oz
Hauteur totale [A] Overall height	283,6 mm 11.17 in	276,6 mm 10.89 in	296,8 mm 11.69 in	289,8 mm 11.41 in
Diamètre Pied [B] Base diameter	96,8 mm 3.81 in	96,8 mm 3.81 in	91,6 mm 3.61 in	91,6 mm 3.61 in
Diamètre Épaule [C] Shoulder diameter	81 mm 3.19 in	81 mm 3.19 in	72,2 mm 2.84 in	72,2 mm 2.84 in
Diamètre de débouchage [D] Entrance bore diameter	18,5 mm 0.73 in	18,5 mm 0.73 in	18,5 mm 0.73 in	18,5 mm 0.73 in
Teinte Glass color	● Antique Antique Green ○ Extra Blanc Extra White Flint	● Antique Antique Green ○ Extra Blanc Extra White Flint	● Antique Antique Green ○ Extra Blanc Extra White Flint	● Antique Antique Green ○ Extra Blanc Extra White Flint

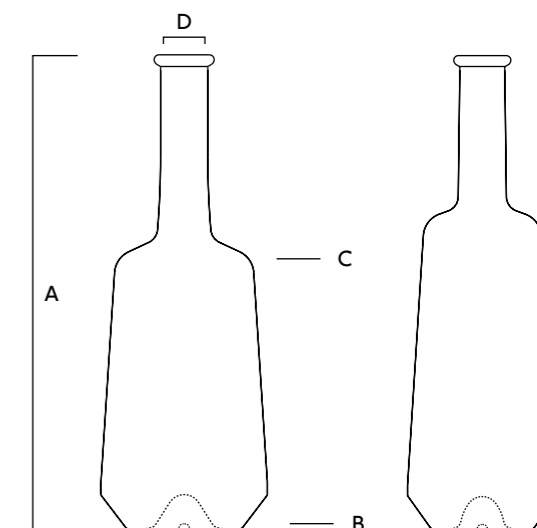

NOUVEAUX CONCEPTS THEOS WINE

SUPER PREMIUM



Volontairement transgressive, la bouteille THEOS WINE opère une rupture franche vis-à-vis des « figures imposées » que sont les silhouettes génériques bordelaises, bourguignonnes ou flûtes. Son design décalé et innovant revendique un nouveau territoire d'expression et de créativité dans le domaine quelque peu figé des bouteilles de vin. Dédié prioritairement aux « Nouveaux Concepts Vins », THEOS WINE s'adresse aux néo-consommateurs en quête de repères attractifs, contemporains et intrigants.

Deliberately transgressive, the THEOS WINE bottle makes a clean break from the traditional norms represented by generic Bordelaise, Burgundian or Hock shapes. Its innovative and out-of-step design ventures into new creative and expressive territories within the somewhat sedate world of wine bottles. Dedicated to "New Wine Concepts", THEOS WINE is aimed at trendy consumers seeking attractive, contemporary and intriguing benchmarks.



Contenance
Capacity

75 cl
25.36 oz

Référence
Reference

3775

Bague
Finish



Plate FA

Poids
Weight

720 g
25.40 oz

Hauteur
totale [A]
Overall
height

325,5 mm
12.81 in

Diamètre
Pied [B]
Base
diameter

81,3 mm
3.20 in

Diamètre
Épaule [C]
Shoulder
diameter

45,7 mm
1.80 in

Diamètre de
débouchage
[D] Entrance
bore diameter

18,5 mm
0.75 in

Teinte
Glass color

● Antique*
Antique Green
○ Extra Blanc
Extra White Flint

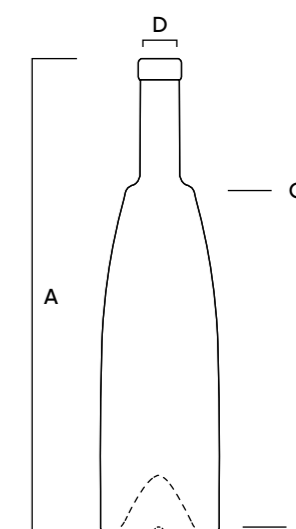

* : Sur commande Made to order
Modèle déposé « Design Saverglass »
Registered "Design Saverglass"

NOUVEAUX CONCEPTS

ALTO



PREMIUM +



Plus aérienne, encore plus légère et toujours plus svelte, ALTO assume les superlatifs avec une assurance déconcertante! Cette silhouette distinctive à l'allure ultra-pointue se démarque par son style hybride, ni tout à fait flûte, ni tout à fait bourgogne. Mais au-delà de son poids plume (560 g seulement), ALTO dispose d'un autre atout grâce à son étonnant fond plat. Cette particularité qui la distingue des bouteilles avec piqûre offre un formidable support pour de précieuses gravures aux accents très «couture». Extreme oriental: cette gravure emprunte à l'Orient ses arabesques et ses motifs complexes, évoquant les bijoux précieux rapportés d'une expédition lointaine.

More refined, even lighter and more slender, ALTO is not afraid to be the best! Its distinctive silhouette has an ultra-sharp look and stands out because of its hybrid style, not fully hock or Burgundy. But beyond being lighter than a feather (only 560 g), ALTO boasts another advantage thanks to its amazing flat base. This special feature—which sets it apart from bottles with a punt—is a great canvas for precious engravings with "couture" accents. Extreme oriental: this engraving borrows its arabesque and intricate patterns from the East, evoking the memory of the sight of precious jewellery found on a distant expedition.



Contenance Capacity	75 cl 25.36 oz	75 cl 25.36 oz	75 cl 25.36 oz	75 cl 25.36 oz
Référence Reference	6740	6741	6742	6743
Bague Finish	 Plate FA	 Plate FA	 Plate FA	 Plate FA
Poids Weight	560 g 19.75 oz	560 g 19.75 oz	568 g 20.04 oz	560 g 19.75 oz
Hauteur totale [A] Overall height	317 mm 12.48 in	317 mm 12.48 in	317 mm 12.48 in	317 mm 12.48 in
Diamètre pied [B] Base diameter	92,1 mm 3.63 in	92,1 mm 3.63 in	92,1 mm 3.63 in	92,1 mm 3.63 in
Diamètre Corps [C] Body diameter	86,6 mm 3.41 in	86,6 mm 3.41 in	86,6 mm 3.41 in	86,6 mm 3.41 in
Diamètre de débouchage [D] Entrance bore diameter	18,5 mm 0.73 in	18,5 mm 0.73 in	18,5 mm 0.73 in	18,5 mm 0.73 in
Teinte Glass color	○ Extra Blanc Extra White Flint	○ Extra Blanc Extra White Flint	○ Extra Blanc Extra White Flint	○ Extra Blanc Extra White Flint

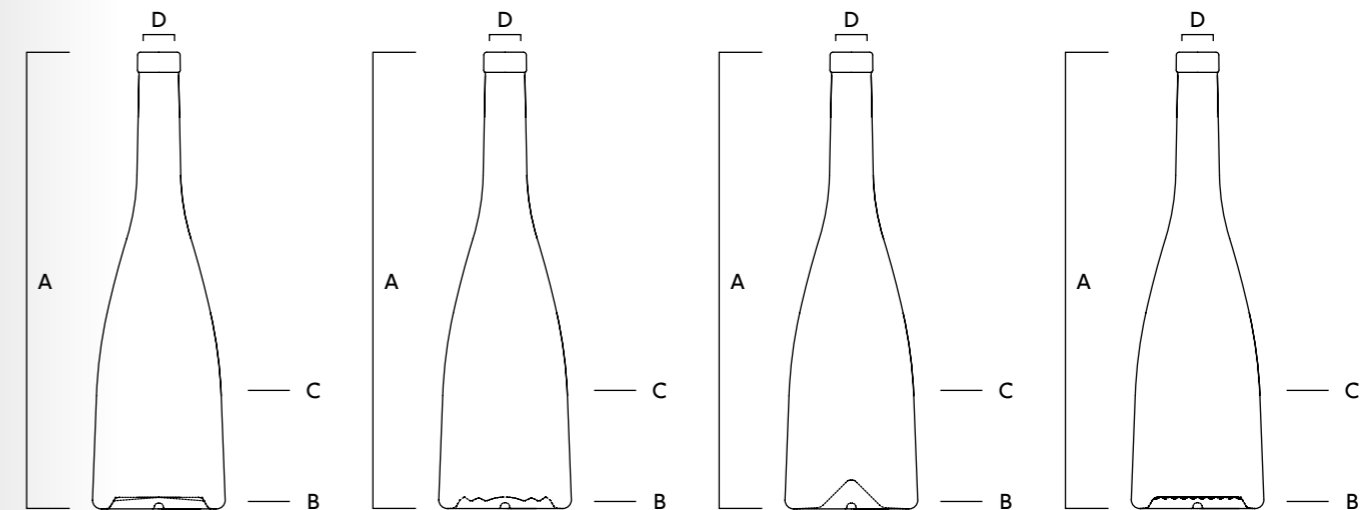

NOUVEAUX CONCEPTS ANTIK PREMIUM +



Les Bordelaise et Bourgogne ANTIK réinterprètent le dessin des modèles en verre soufflés qui contenaient autrefois les grands crus. Revisitant la tradition et s'appuyant sur les technologies verrières de pointe, Saverglass insuffle un vent de modernité et s'inspire du vintage pour créer deux modèles uniques, qui réinterprètent l'icône amphore et offrent une relecture contemporaine des codes de l'authenticité. De hauteur modeste, Bordelaise et Bourgogne ANTIK affichent une épaule très marquée et une piqûre avec boudine.

The Bordelaise and Bourgogne ANTIK are reinterpretations of the hand-blown-glass bottles that enclosed the grands crus of yesteryear. Revisiting this tradition and applying the latest glassmaking technologies, Saverglass provides a modern twist inspired by vintage designs to create two unique models that reinterpret the iconic amphora and offer a fresh contemporary approach to authentic codes. Bordelaise and Bourgogne ANTIK models are modest in height and boast generous shoulders and a "boudine" in the punt.



	BORDELAISE ANTIK	BORDELAISE ANTIK VINTAGE	BOURGOGNE ANTIK	BOURGOGNE ANTIK BVS	BOURGOGNE ANTIK
Contenance Capacity	75 cl 25.36 oz	75 cl 25.36 oz	75 cl 25.36 oz	75 cl 25.36 oz	150 cl 50.73 oz
Référence Reference	5060	5601*	5564	6385	5697
Bague Finish	 Plate SB 29	 Plate SB 29	 Carrée Bourgogne SB 29	 BVS 30H60	 Carrée Bourgogne SB 29
Poids Weight	660 g 23.28 oz	660 g 23.28 oz	629 g 22.19 oz	641 g 22.61 oz	1120 g 39.51 oz
Hauteur totale [A] Overall height	266 mm 10.47 in	266 mm 10.47 in	267 mm 10.51 in	267 mm 10.51 in	332,6 mm 13.09 in
Diamètre Pied [B] Base diameter	78,9 mm 3.11 in	78,9 mm 3.11 in	92 mm 3.62 in	92,2 mm 3.63 in	116,2 mm 4.57 in
Diamètre Épaule [C] Shoulder diameter	88,8 mm 3.50 in	88,8 mm 3.50 in	98 mm 3.86 in	98,2 mm 3.87 in	123,6 mm 4.87 in
Diamètre de débouchage [D] Entrance bore diameter	18,5 mm 0.73 in	18,5 mm 0.73 in	18,5 mm 0.73 in	20 mm 0.79 in	18,5 mm 0.73 in
Teinte Glass color	● Antique Antique Green ○ Extra Blanc Extra White Flint	● Antique Antique Green	● Antique Antique Green ○ Extra Blanc Extra White Flint	● Antique Antique Green ○ Extra Blanc Extra White Flint	● Antique Antique Green ○ Extra Blanc Extra White Flint

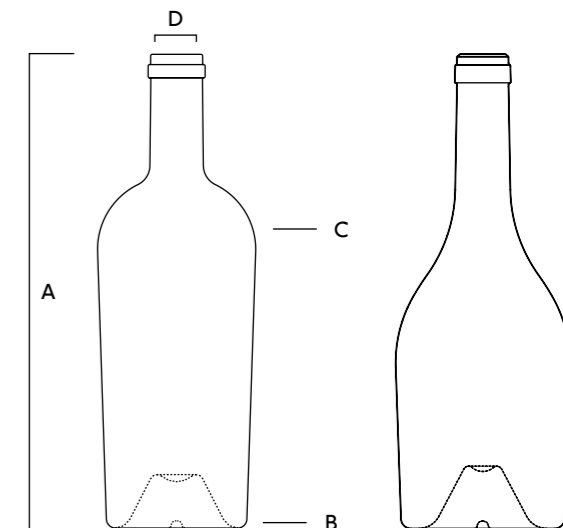

* : Sur commande Made to order

NOUVEAUX CONCEPTS ÉCLAT

PREMIUM +



Le concept ÉCLAT dévoile de nouvelles piqûres conçues pour révéler l'éclat et la brillance du verre Extra-Blanc de Saverglass et mettre en valeur les tonalités subtiles et raffinées des vins blancs et des vins rosés. Il est réalisé à partir du modèle Bordelaise ÉCLAT qui se distingue par une hauteur de 320 mm en 75 cl, une épaule charnue ainsi qu'une légère conicité du corps et un col effilé. ÉCLAT tire également son originalité des six formes de gravure qui favorisent ainsi la concentration de la lumière.

The ÉCLAT concept unveils new punts designed to showcase the radiance and brilliance of the Saverglass Extra-White flint glass, and to highlight the subtle, refined tonalities of white and rosé wines. It is based on the Bordelaise ÉCLAT model, characterized by a height of 320mm in 75cl, a plump shoulder and a slight taper in the body with a long, slim neck. The originality of ÉCLAT is enhanced by its six etched motifs, which concentrate light.

NOUVEAUX CONCEPTS ÉCLAT

PREMIUM +



	ÉCLAT STAR SHINING	ÉCLAT FALLING STAR	ÉCLAT CONSTELLATION	ÉCLAT CONSTELLATION BVS	ÉCLAT CONSTELLATION
Contenance Capacity	75 cl 25.36 oz	75 cl 25.36 oz	75 cl 25.36 oz	75 cl 25.36 oz	150 cl 50.73 oz
Référence Reference	5217	5220	5219	5858	5442
Bague Finish	Plate FA	Plate FA	Plate FA	BVS 30H60	Plate FA
Poids Weight	608 g 21.45 oz	600 g 21.16 oz	600 g 21.16 oz	610 g 21.52 oz	980 g 34.57 oz
Hauteur totale [A] Overall height	320 mm 12.60 in	320 mm 12.60 in	320 mm 12.60 in	318 mm 12.52 in	392,2 mm 15.44 in
Diamètre Pied [B] Base diameter	71,6 mm 2.82 in	71,6 mm 2.82 in	71,6 mm 2.82 in	71,4 mm 2.81 in	88,3 mm 3.48 in
Diamètre Épaule [C] Shoulder diameter	77,5 mm 3.05 in	77,5 mm 3.05 in	77,5 mm 3.05 in	77,3 mm 3.04 in	95,8 mm 3.77 in
Diamètre de débouchage [D] Entrance bore diameter	18,5 mm 0.73 in	18,5 mm 0.73 in	18,5 mm 0.73 in	20 mm 0.79 in	18,5 mm 0.73 in
Teinte Glass color	○ Extra Blanc Extra White Flint	○ Extra Blanc Extra White Flint	○ Extra Blanc Extra White Flint	○ Extra Blanc Extra White Flint	○ Extra Blanc Extra White Flint

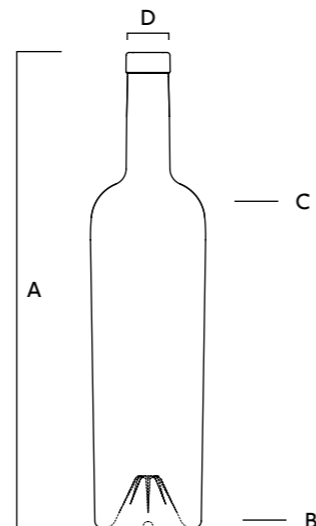

	ÉCLAT CONSTELLATION	ÉCLAT MOON RISING**	ÉCLAT MOON RISING**	ÉCLAT FUSION	ÉCLAT GALAXY	ÉCLAT GALAXY
Contenance Capacity	300 cl 101.45 oz	75 cl 25.36 oz	150 cl 50.73 oz	75 cl 25.36 oz	75 cl 25.36 oz	150 cl 50.73 oz
Référence Reference	6250	5218	5600*	5565*	5566	5748
Bague Finish	Plate SB 36,5	Plate FA	Plate FA	Plate FA	Plate FA	Plate FA
Poids Weight	1733 g 61.13 oz	600 g 21.16 oz	985 g 34.74 oz	600 g 21.16 oz	600 g 21.16 oz	982 g 34.64 oz
Hauteur totale [A] Overall height	492,9 mm 19.41 in	320 mm 12.60 in	392,2 mm 15.44 in	320 mm 12.60 in	320 mm 12.60 in	392,2 mm 15.44 in
Diamètre Pied [B] Base diameter	111,1 mm 4.37 in	71,6 mm 2.82 in	88,3 mm 3.48 in	71,6 mm 2.82 in	71,6 mm 2.82 in	88,3 mm 3.48 in
Diamètre Épaule [C] Shoulder diameter	120,3 mm 4.74 in	77,5 mm 3.05 in	95,8 mm 3.77 in	77,5 mm 3.05 in	77,5 mm 3.05 in	95,8 mm 3.77 in
Diamètre de débouchage [D] Entrance bore diameter	24 mm 0.94 in	18,5 mm 0.73 in	18,5 mm 0.73 in	18,5 mm 0.73 in	18,5 mm 0.73 in	18,5 mm 0.73 in
Teinte Glass color	○ Extra Blanc Extra White Flint	○ Extra Blanc Extra White Flint	○ Extra Blanc Extra White Flint	○ Extra Blanc Extra White Flint	○ Extra Blanc Extra White Flint	○ Extra Blanc Extra White Flint

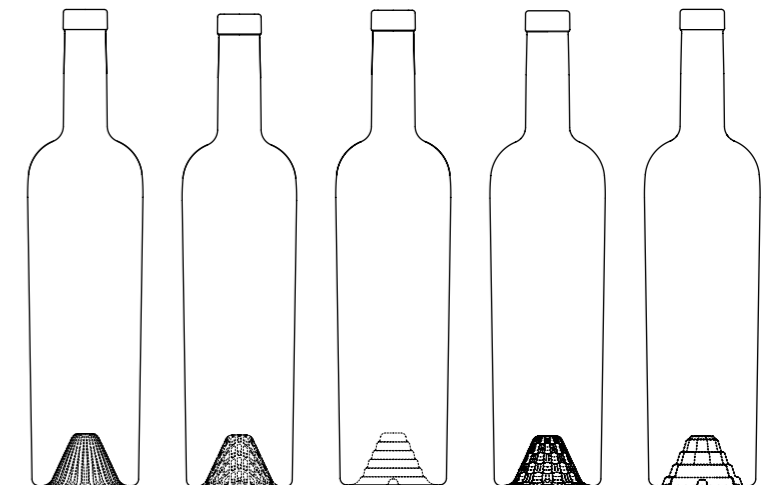

* : Sur commande Made to order
 **: Nous consulter pour toute commande en France
 Modèle déposé « Design Saverglass »
 Registered "Design Saverglass"

NOUVEAUX CONCEPTS IRRÉSISTIBLE





PREMIUM +



IRRÉSISTIBLE consacre entièrement son design esthétique et fonctionnel au service du vin. Elle s'affirme d'ailleurs dans cet univers comme un modèle incontournable aux lignes dynamiques, déployant un col d'une grande finesse, un épaulement fuselé, une piqûre moderne en pointe fine, une haute stature et un fût légèrement conique. Dotés de différentes gravures aux traits subtils et finement esquissés sur le bas fût de la bouteille, les modèles IRRÉSISTIBLE proposent une alternative originale et très graphique pour personnaliser les contenants et jouer la carte de la différenciation.

With its aesthetic and functional design, the IRRÉSISTIBLE line is dedicated strictly to serving wine. And it has staked out its claim in this environment as a consummate model with its dynamic lines, highly elegant neck, tapered shoulders, modern fine-point punt, statuesque height and a slightly conical base. Featuring subtly engraved designs on their bases, the IRRÉSISTIBLE designs are original and highly graphic alternatives for customizing containers that set them apart from the rest.



	IRRÉSISTIBLE	IRRÉSISTIBLE LINES	IRRÉSISTIBLE QUB	IRRÉSISTIBLE 2ND SKIN	IRRÉSISTIBLE 2ND SKIN
Contenance Capacity	75 cl 25.36 oz	75 cl 25.36 oz	75 cl 25.36 oz	75 cl 25.36 oz	150 cl 50.73 oz
Référence Reference	5788	5826*	5827	5828	6101
Bague Finish	 Plate FA	 Plate FA	 Plate FA	 Plate FA	 Plate FA
Poids Weight	628 g 22.15 oz	628 g 22.15 oz	628 g 22.15 oz	628 g 22.15 oz	1160 g 40.92 oz
Hauteur totale [A] Overall height	330 mm 12.99 in	330 mm 12.99 in	330 mm 12.99 in	330 mm 12.99 in	410,4 mm 16.16 in
Diamètre Pied [B] Base diameter	71,1 mm 2.80 in	71,5 mm 2.81 in	71,1 mm 2.80 in	71,1 mm 2.80 in	90 mm 3.54 in
Diamètre Épaule [C] Shoulder diameter	75,1 mm 2.96 in	75,5 mm 2.97 in	75,1 mm 2.96 in	75,1 mm 2.96 in	95 mm 3.74 in
Diamètre de débouchage [D] Entrance bore diameter	18,5 mm 0.73 in	18,5 mm 0.73 in	18,5 mm 0.73 in	18,5 mm 0.73 in	18,5 mm 0.73 in
Teinte Glass color	● Antique* Antique Green ○ Extra Blanc Extra White Flint	○ Extra Blanc Extra White Flint	○ Extra Blanc Extra White Flint	○ Extra Blanc Extra White Flint	○ Extra Blanc Extra White Flint

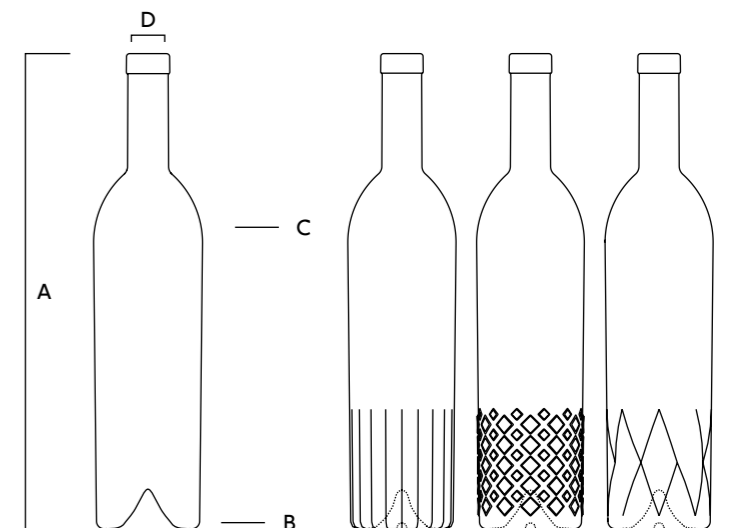

* : Sur commande Made to order
Modèle déposé « Design Saverglass »
Registered "Design Saverglass"

NOUVEAUX CONCEPTS MERVEILLEUSE

PREMIUM +







Si l'on devine l'héritage des formes traditionnelles, il se combine à la créativité d'un design unique pour révéler une silhouette totalement revisitée. Et le résultat est absolument irrésistible : de taille modeste (241,3 mm), la BOURGOGNE MERVEILLEUSE se singularise par une épaule exceptionnellement charnue, une conicité marquée, un col svelte et une petite pique ronde. Destiné à conserver tous les vins merveilleux, ce flacon replet évoque toute la volupté d'une douceur sucrée à laquelle il est impossible de résister.

A legacy of traditional shapes is combined with a creative, unique design, resulting in a completely reimagined silhouette. And the result is absolutely irresistible: modest in size (241.3 mm), the BOURGOGNE MERVEILLEUSE is one of a kind due to its exceptionally rounded shoulder, a marked taper, a slender neck and a small round punt. Designed to hold all sorts of marvellous wines, this curved bottle evokes the delight of an irresistible sweetness.



BG MERVEILLEUSE BG MERVEILLEUSE BX MERVEILLEUSE BX MERVEILLEUSE

Contenance Capacity	75 cl 25.36 oz	150 cl 50.73 oz	75 cl 25.36 oz	150 cl 50.73 oz
Référence Reference	* 6745	* 6746	6744	6747
Bague Finish	 Plate SB30	 Plate SB30	 Plate SB30	 Plate SB30
Poids Weight	620 g 21.87 oz	1192 g 42.05 oz	620 g 21.87 oz	1183 g 41.73 oz
Hauteur totale [A] Overall height	241,3 mm 9.50 in	291,5 mm 11.48 in	237,1 mm 9.33 in	291,5 mm 11.48 in
Diamètre pied [B] Base diameter	85,8 mm 3.38 in	107,2 mm 4.22 in	81,8 mm 3.22 in	104 mm 4.09 in
Diamètre épaule [C] Shoulder diameter	105 mm 4.13 in	130,8 mm 5.15 in	96 mm 3.78 in	121,9 mm 4.80 in
Diamètre de déouchage [D] Entrance bore diameter	18,5 mm 0.73 in	18,5 mm 0.73 in	18,5 mm 0.73 in	18,5 mm 0.73 in
Teinte Glass color	● Antique Antique Green ○ Extra Blanc Extra White Flint	● Antique Antique Green ○ Extra Blanc Extra White Flint	● Antique Antique Green ○ Extra Blanc Extra White Flint	● Antique Antique Green ○ Extra Blanc Extra White Flint

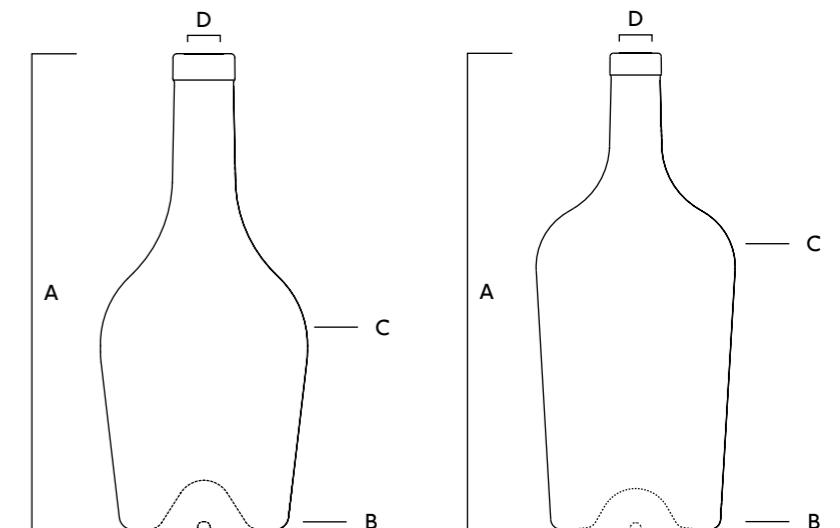

*Modèle déposé « Design Saverglass »
Registered "Design Saverglass"

NOUVEAUX CONCEPTS

SOPHIA



PREMIUM +



Le modèle SOPHIA affiche un style moderne et ludique. Dotée d'une semelle de verre singulière faisant effet de piédestal, la charismatique SOPHIA déploie des lignes féminines combinant un fût harmonieusement galbé à un col long et cylindrique surmonté d'une bague plate.

SOPHIA offers a modern playful style. Its singular glass base forms a kind of pedestal, while SOPHIA seduces with its feminine lines that combine a harmonious body curving upward to a long cylindrical bar top finish.



Contenance Capacity	75 cl 25.36 oz	150 cl 50.73 oz
Référence Reference	3628	4698
Bague Finish	 Plate FA	 Plate FA
Poids Weight	640 g 22.57 oz	1179 g 41.59 oz
Hauteur totale [A] Overall height	330 mm 12.99 in	397,8 mm 15.66 in
Diamètre Pied [B] Base diameter	69,1 mm 2.72 in	89 mm 3.50 in
Diamètre Corps [C] body diameter	84 mm 3.31 in	108,1 mm 4.26 in
Diamètre de débouchage [D] Entrance bore diameter	18,5 mm 0.73 in	18,5 mm 0.73 in
Teinte Glass color	● Antique Antique Green ○ Extra Blanc Extra White Flint	● Antique* Antique Green ○ Extra Blanc Extra White Flint

* : Sur commande Made to order
Modèle déposé « Design Saverglass »
Registered "Design Saverglass"

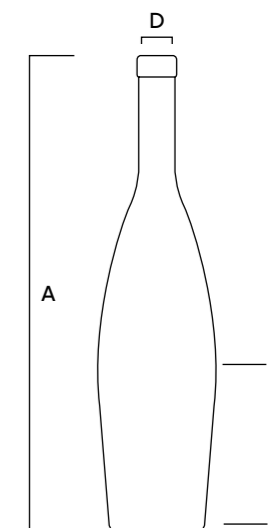

NOUVEAUX CONCEPTS TASTEVINE CONSTELLATION

PREMIUM +

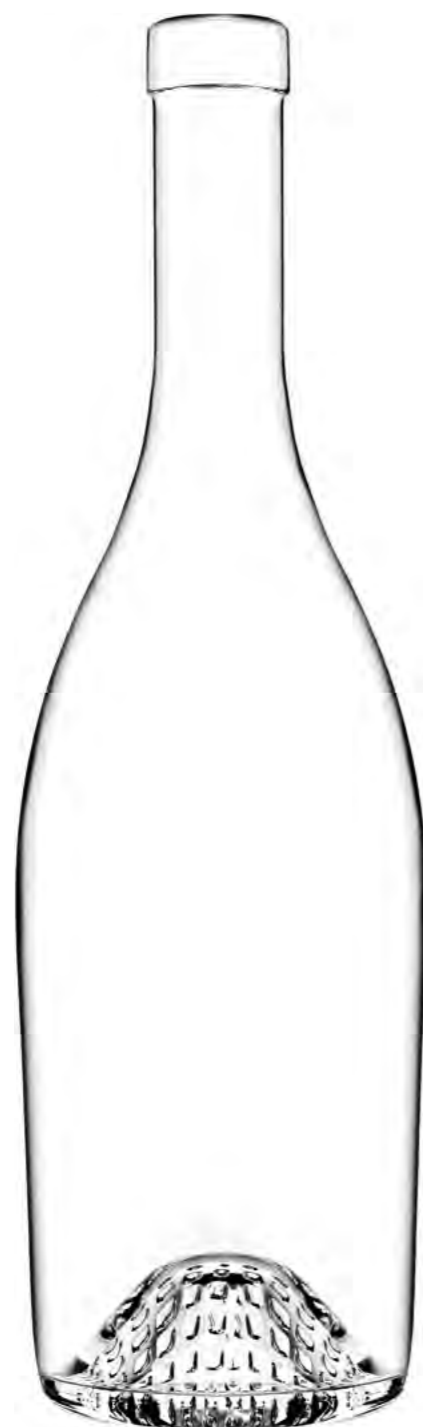

TASTEVINE CONSTELLATION se caractérise par l'harmonie de sa silhouette: un fût légèrement conique réhaussé par des épaules galbées, et prolongé d'un long col cylindrique. L'un de ses traits remarquables réside dans sa piqûre carrée prononcée pourvue d'une gravure qui ravive l'éclat et la brillance du verre Extra-Blanc de Saverglass. Constellation: une multitude de motifs carrés habitent la piqûre, et créent une constellation. Un souci d'esthétisme poussé dans ses moindres détails: le motif se poursuit jusque sur le plan de pose et fait office de moletage...

TASTEVINE CONSTELLATION is characterized by the harmony of the shape: a subtly tapered body emphasized by shoulders which curve into a long cylindrical neck. One special feature is its square punt with an engraving to enhance the radiance and brilliance of the Extra-White flint glass from Saverglass. Constellation: a cluster of square motifs cover the punt, creating a constellation. Beauty has been sought in the smallest detail: the motif continues to the base of the bottle where it functions as the knurling.



Contenance
Capacity

75 cl
25.36 oz

Référence
Reference

5773

Bague
Finish



Plate VDL

Poids
Weight

676 g
23.84 oz

Hauteur
totale [A]
Overall
height

300,1 mm
11.81 in

Diamètre
Pied [B]
Base
diameter

83,8 mm
3.30 in

Diamètre
Épaule [C]
Shoulder
diameter

89,3 mm
3.52 in

Diamètre de
débouchage
[D] Entrance
bore diameter

18,5 mm
0.75 in

Teinte
Glass color

○ Extra Blanc
Extra White Flint

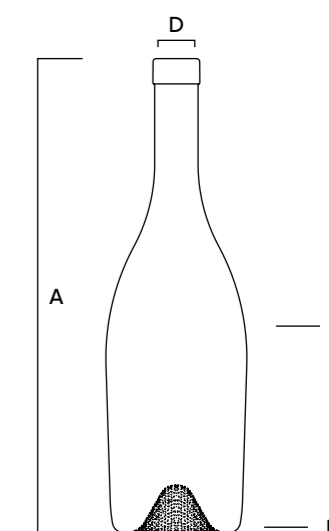

Modèle déposé « Design Saverglass »
Registered "Design Saverglass"

NOUVEAUX CONCEPTS VIN GRAND CRU ZEBRA

PREMIUM +

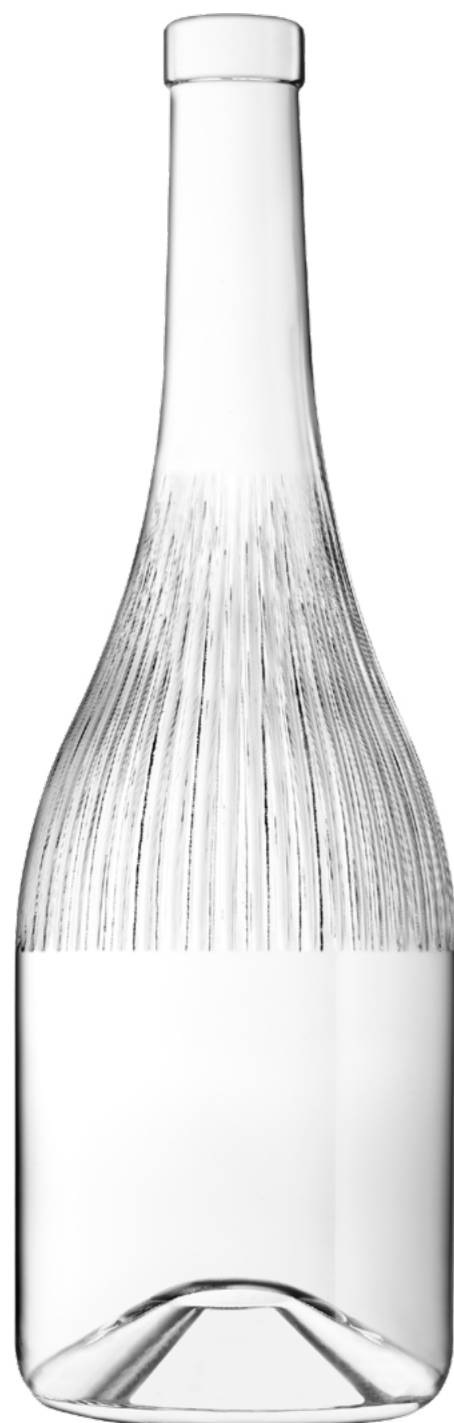

Née d'un brillant exercice stylistique, VIN GRAND CRU ZEBRA s'affirme comme un contrepied élégant aux traditionnels flacons. Cette bouteille au corps râblé et dont l'épaule basse prolonge un long col très élégant prouve son irrésistible audace à travers de fines gravures verticales. Ces petites stries chics habillent le flacon depuis l'épaule jusque dans le bas col et métamorphosent ainsi ce contenant à l'apparence classique en un véritable objet de curiosité. Le bas-fût demeure quant à lui lisse afin de laisser le champ libre à toutes les personnalisations.

Designed from a brilliant stylistic experiment, VIN GRAND CRU ZEBRA bursts onto the scene as an elegant contrast to traditional bottles. The bottle has a sturdy body, with a long, elegant neck further elongated by its low shoulders, proving its irresistible boldness through fine vertical engravings. These chic, slim stripes adorn the bottle from the shoulders to the lower neck, transforming the classic container into a truly curious piece. The lower section remains smooth, a canvas for all types of customization.



Contenance
Capacity

75 cl
25.36 oz

Référence
Reference

6642

Bague
Finish



Plate FA

Poids
Weight

664 g
23.42 oz

Hauteur
totale [A]
Overall
height

292 mm
11.50 in

Diamètre pied [B]
Base diameter

91,7 mm
3.61 in

Diamètre épaule [C]
Shoulder diameter

92,7 mm
3.65 in

Diamètre de
débouchage [D]
Entrance
bore diameter

18,5 mm
0.73 in

Teinte
Glass color

● Antique
Antique Green
○ Extra Blanc
Extra White Flint

Modèle déposé « Design Saverglass »
Registered "Design Saverglass"

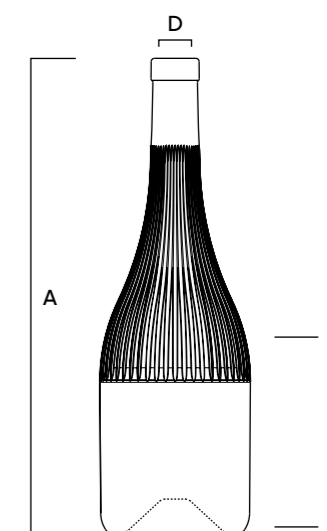

NOUVEAUX CONCEPTS INVENT PREMIUM



La ligne INVENT propose une « nouvelle piqure signature » au design avant-gardiste, aux lignes douces qui sculptent avec caractère le fond de la bouteille pour en modifier subtilement le bas-fût tout en préservant l'identité des contenants. INVENT relève le défi d'un design responsable: économiser matière et énergie tout en conservant les codes originaux en proposant une hauteur de 296 mm pour la forme Bourgogne, et 300 mm pour la forme Bordelaise.

The INVENT line offers a "new signature punt" with its avant-garde design. Softlines lend character to the base of the bottle, subtly altering the base while preserving the identity of the content. INVENT takes up the challenge of eco-responsible design: saving materials and energy while respecting the basic codes, with a height of 296 mm for the Burgundy shape, and 300 mm for the Bordeaux Shape.



BORDELAISE INVENT



BOURGOGNE INVENT

Contenance Capacity	75 cl 25.36 oz	75 cl 25.36 oz
Référence Reference	5342	5396
Bague Finish	 Plate Unique	 Plate Unique
Poids Weight	521 g 18.38 oz	519 g 18.31 oz
Hauteur totale [A] Overall height	300 mm 11.81 in	296 mm 11.65 in
Diamètre Corps [B] Body diameter	75,4 mm 2.97 in	84 mm 3.31 in
Diamètre de débouchage [C] Entrance bore diameter	18,5 mm 0.73 in	18,5 mm 0.73 in
Teinte Glass color	● Antique Antique Green ○ Extra Blanc Extra White Flint	● Antique Antique Green ○ Extra Blanc Extra White Flint

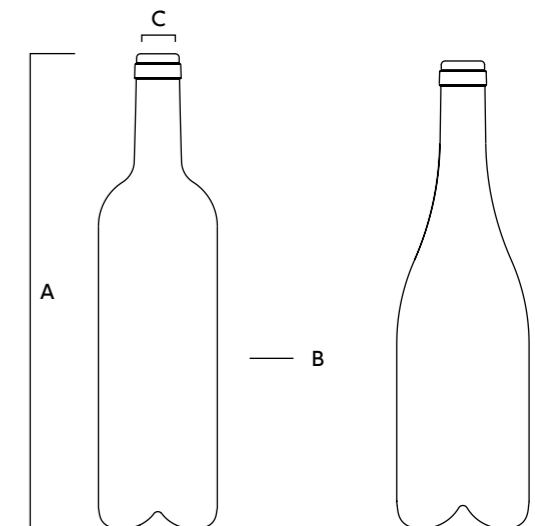

ALCOHOLS

HOCKS

FLÛTE ALLEGRO

SUPER PREMIUM



Une forme pure et tendue, particulièrement longiligne, caractérise la Flûte ALLEGRO qui s'inscrit dans les tendances des bouteilles extra hautes. Sa piqûre profonde, en forme d'ogive, renforce l'originalité des flacons et souligne la conicité de son fût.

A simple and straight form, particularly tall and slender, characterizes the Flute ALLEGRO, which is part of the extra tall range. Its warhead-shaped deep punt emphasizes the originality of the bottles and enhances the tapering of the body.



Contenance
Capacity

50 cl
16.91 oz

75 cl
25.36 oz

Référence
Reference

2510*

2509*

Bague
Finish



Plate FA



Plate FA

Poids
Weight

560 g
19.75 oz

780 g
27.51 oz

Hauteur
totale [A]
Overall
height

350 mm
13.78 in

372 mm
14.65 in

Diamètre
Pied [B]
Base
diameter

70 mm
2.76 in

82,5 mm
3.25 in

Diamètre
Épaule [C]
Shoulder
diameter

62,8 mm
2.47 in

74,2 mm
2.92 in

Diamètre de
débouchage
[D] Entrance
bore diameter

18,5 mm
0.73 in

18,5 mm
0.73 in

Teinte
Glass color

● Antique
Antique Green
○ Extra Blanc
Extra White Flint

● Antique
Antique Green

* : Sur commande Made to order
Modèle déposé « Design Saverglass »
Registered "Design Saverglass"

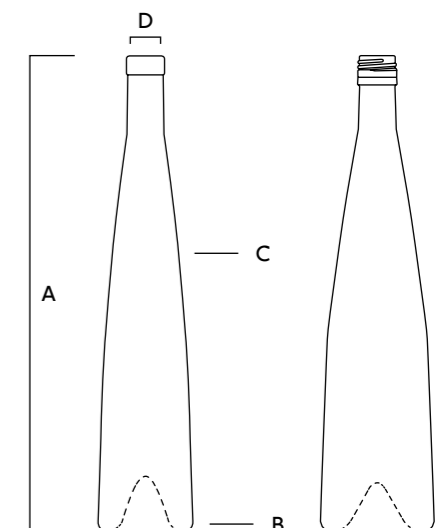

FLÛTE ALTUS

SUPER PREMIUM



Allure altière et moderne pour la flûte ALTUS dont l'esthétique très svelte se prête idéalement à une association avec la bague BVS 30H60. Cette silhouette très pure se décline également dans une version personnalisable: dotée d'une plage circulaire permettant une gravure précise en légère saillie, la Flûte ALTUS bas-relief offre un support idéal aux options de personnalisation les plus créatives (frise géométrique, texte, scène figurative...).

The Flute ALTUS exhibits a proud and modern allure, with its ultra-sleek aesthetic that is ideally suited to the BVS 30H60 screw finish. This very pure silhouette is also available in a customizable version: the heel of the Flûte ALTUS has a circular band to enable precise engraving, the ideal backdrop to the most creative customization options (geometric borders, writing, figurative scenes, etc.).



ALTUS BVS



ALTUS BVS



ALTUS BAS-RELIEF



ALTUS BVS

Contenance Capacity	37,5 cl 12.68 oz	75 cl 25.36 oz	75 cl 25.36 oz	150 cl 50.73 oz
Référence Reference	3479	3224	2749*	4937
Bague Finish	 BVS 30H60	 BVS 30H60	 Plate FA	 BVS 30H60
Poids Weight	438 g 15.45 oz	710 g 25.04 oz	660 g 23.28 oz	1256 g 44.30 oz
Hauteur totale [A] Overall height	305 mm 12.01 in	357,3 mm 14.07 in	357,3 mm 14.07 in	478 mm 18.82 in
Diamètre Corps [B] Body diameter	60,7 mm 2.39 in	79,2 mm 3.12 in	77,7 mm 3.06 in	93,5 mm 3.68 in
Diamètre de débouchage [C] Entrance bore diameter	20 mm 0.79 in	20 mm 0.79 in	18,5 mm 0.73 in	19 mm 0.75 in
Teinte Glass color	● Antique Antique Green ○ Extra Blanc Extra White Flint	● Antique Antique Green	● Antique Antique Green ● Champagne Champagne Green	● Antique Antique Green

* : Sur commande Made to order

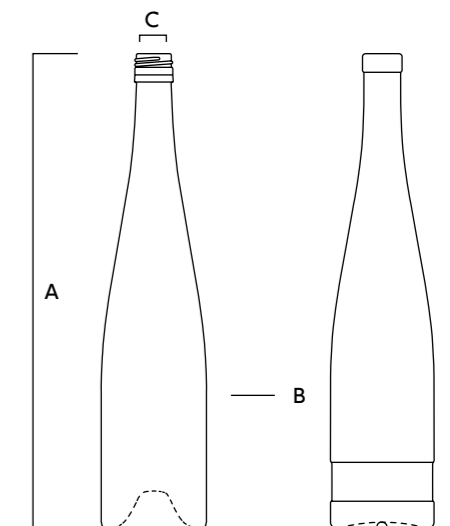

FLÛTE ALTUS WINE

STANDARD PREMIUM



La gamme ALTUS WINE réussit la performance de renouveler avec élégance et simplicité la silhouette traditionnelle de la flûte. Valorisés par une ligne haute très flatteuse, une épaule à peine esquissée et une bague plate, les différents modèles de la gamme brillent par leur tempérament résolument moderne.

The ALTUS WINE range has elegantly and simply updated the traditional hock silhouette. Highlighted by a flattering tall line, a flowing shoulder and a plate finish, the various models in the range shine through their resolutely modern appearance.



Contenance Capacity	37,5 cl 12.68 oz	50 cl 16.91 oz	75 cl 25.36 oz	150 cl 50.73 oz	300 cl 101.45 oz
Référence Reference	2079	2080	2081	0719	2665*
Bague Finish	 Plate FA	 Plate FA	 Plate FA	 Plate FA	 Plate FA
Poids Weight	420 g 14.81 oz	538 g 18.98 oz	580 g 20.46 oz	1230 g 43.39 oz	1700 g 59.96 oz
Hauteur totale [A] Overall height	305 mm 12.01 in	336 mm 13.23 in	357,3 mm 14.07 in	478 mm 18.82 in	521,3 mm 20.52 in
Diamètre Corps [B] Body diameter	61,3 mm 2.41 in	68,1 mm 2.68 in	77,7 mm 3.06 in	93,5 mm 3.68 in	121 mm 4.76 in
Diamètre de débouchage [C] Entrance bore diameter	18,5 mm 0.73 in	18,5 mm 0.73 in	18,5 mm 0.73 in	18,5 mm 0.73 in	24 mm 0.94 in
Teinte Glass color	● Antique Antique Green ○ Extra Blanc Extra White Flint	● Antique Antique Green ○ Extra Blanc Extra White Flint	● Antique Antique Green ○ Extra Blanc Extra White Flint	● Antique Antique Green ○ Extra Blanc Extra White Flint ● Champagne* Champagne Green	● Antique Antique Green

* : Sur commande Made to order

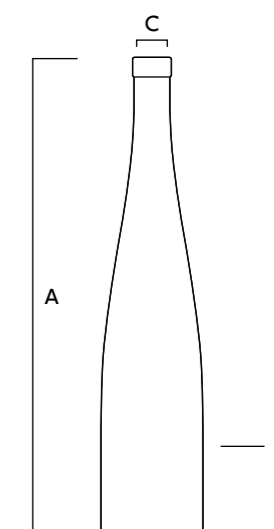

FLÛTE TRADITION

STANDARD PREMIUM



La gamme TRADITION se compose de flûtes type Alsace permettant d'associer deux principes de bouchage: bague plate unique (type cétie) et bague à vis BVS 30H60.



The TRADITION range is made up of Alsace type flutes suitable for two capping principles: cétie type and BVS 30H60 screw finish.



STANDARD



STANDARD BVS

Contenance Capacity	75 cl 25.36 oz	75 cl 25.36 oz
Référence Reference	T093	3220
Bague Finish	 Plate Unique	 BVS 30H60
Poids Weight	535 g 18.87 oz	600 g 21.16 oz
Hauteur totale [A] Overall height	329 mm 12.95 in	329 mm 12.95 in
Diamètre Corps [B] Body diameter	76,9 mm 3.03 in	77,5 mm 3.05 in
Diamètre de débouchage [C] Entrance bore diameter	18,5 mm 0.73 in	20 mm 0.79 in
Teinte Glass color	● Antique Antique Green	● Antique Antique Green

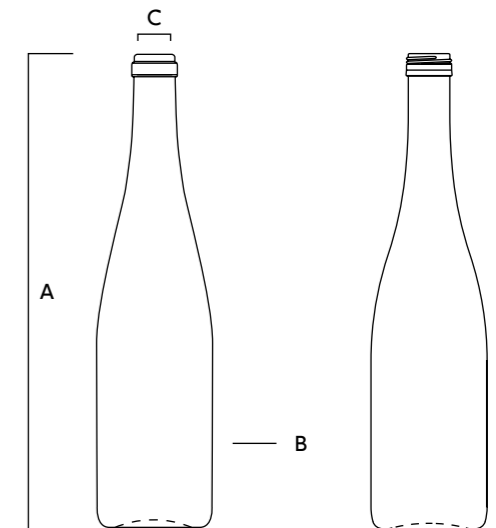

FLÛTE VIN CLUB

STANDARD PREMIUM



La gamme VIN CLUB offre une évolution esthétiquement réussie et maîtrisée de la flûte Alsace traditionnelle. Autre facteur de succès: la diversité des contenances et des teintes proposées.

The VIN CLUB range offers an accomplished, elegant and refined evolution in the traditional Alsace hock. The variety of capacities and glass colors offered is another factor that adds to the success of this range.



Contenance Capacity	37,5 cl 12.68 oz	50 cl 16.91 oz	75 cl 25.36 oz	75 cl 25.36 oz	150 cl 50.73 oz	300 cl 101.45 oz
Référence Reference	1618	1619	1620	4676	0719	2665*
Bague Finish	 Plate Unique	 Plate Unique	 Cétie Spéciale	 BVS 30H60	 Plate FA	 Plate FA
Poids Weight	495 g 17.46 oz	505 g 17.81 oz	665 g 23.46 oz	585 g 20.63 oz	1230 g 43.39 oz	1700 g 59.96 oz
Hauteur totale [A] Overall height	286 mm 11.26 in	310 mm 12.20 in	353 mm 13.90 in	349 mm 13.74 in	478 mm 18.82 in	521,3 mm 20.52 in
Diamètre Corps [B] Body diameter	65,3 mm 2.57 in	69,2 mm 2.72 in	78,3 mm 3.08 in	77,6 mm 3.06 in	93,5 mm 3.68 in	121 mm 4.76 in
Diamètre de débouchage [C] Entrance bore diameter	18,5 mm 0.73 in	18,5 mm 0.73 in	18,5 mm 0.73 in	20 mm 0.79 in	18,5 mm 0.73 in	24 mm 0.94 in
Teinte Glass color	● Antique Antique Green	● Antique Antique Green ○ Extra Blanc Extra White Flint	● Antique Antique Green	● Antique Antique Green	● Antique Antique Green ○ Extra Blanc Extra White Flint ● Champagne* Champagne Green	● Antique Antique Green

*: Sur commande Made to order

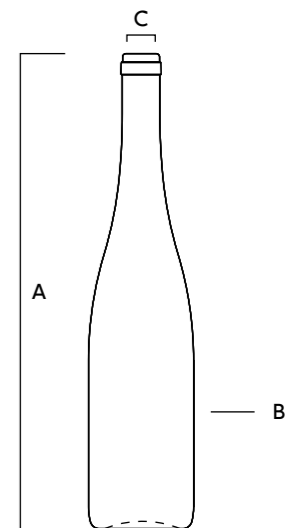

**VINS
EFFER
VES
CENTS**

SPARKLING WINES



CHAMPENOISE ANASSA

ACHIEVEMENTS
RÉALISATIONS



CHAMPENOISE HÉRITAGE



CHAMPENOISE AUSTRAL



CHAMPENOISE ARBANE



CHAMPENOISE ÉCO DESIGN



CHAMPENOISE VINTAGE



CHAMPENOISE ANASSA

EXTRA PREMIUM		PAGE	PROF. GAMME	20 CL	37,5 CL	75 CL	150 CL	300 CL	600 CL
ANASSA	244	1				●			
CUVÉE DES SACRES	246	3				●	●	●	
HÉRITAGE	248	1				●			
CHAMPENOISE TERROIR	250	1				●			

SUPER PREMIUM		PAGE	PROF. GAMME	20 CL	37,5 CL	75 CL	150 CL	300 CL	600 CL
CHAMPENOISE CHORUS	252	1				●			
CHAMPAGNE GRAND CRU	254	3				●	●		
MILLÉSIME	256	1				●			
POMPADOUR	258	1				●			

PREMIUM		PAGE	PROF. GAMME	20 CL	37,5 CL	75 CL	150 CL	300 CL	600 CL
ARBANE	260	3			●	●	●		
CRÉMANT PREMIUM	262	1				●			
CRÉMANT PRESTIGE	264	1				●			
PRESTIGE MÉCANIQUE	266	1				●			
VERTUO	268	1				●			

STANDARD PREMIUM		PAGE	PROF. GAMME	20 CL	37,5 CL	75 CL	150 CL	300 CL	600 CL
AUSTRAL	270	1				●			
CRÉMANT CLASSIC	272	1				●			
ORIGIN	270	1				●			
CHAMPENOISES STANDARD	275	6		●	●	●	●	●	●
ÉCO DESIGN	275	1				●			
VINTAGE	278	1				●			

SPARKLING WINES — RANGE DEPTH OVERVIEW

VINS EFFERVESCENTS – RÉCAPITULATIF PROFONDEUR DE GAMMES

ANASSA	244
ARBANE	260
AUSTRAL	270
CHORUS	252
CRÉMANT CLASSIC	272
CRÉMANT PREMIUM	262
CRÉMANT PRESTIGE	264
CUVÉE DES SACRES	246
CHAMPENOISE ÉCO DESIGN	275
CHAMPAGNE GRAND CRU	254
HÉRITAGE	248
MILLÉSIME	256
ORIGIN	270
PRESTIGE MÉCANIQUE	266
POMPADOUR	258
CHAMPENOISES STANDARD	275
CHAMPENOISE TERROIR	250
VERTUO	268
VINTAGE	278



ANASSA
P. 244



ARBANE
P. 260



AUSTRAL
P. 270



CHORUS
P. 252



CRÉMANT CLASSIC
P. 272



CRÉMANT PREMIUM
P. 262



CRÉMANT PRESTIGE
P. 264



CUVÉE DES SACRES
P. 246



CHAMPENOISE ÉCO DESIGN
P. 275



CHAMPAGNE GRAND CRU
P. 254



HÉRITAGE
P. 248



MILLÉSIME
P. 256



ORIGIN
P. 270



PRESTIGE MÉCANIQUE
P. 266



POMPADOUR
P. 258



CHAMPENOISES STANDARD
P. 275



CHAMPENOISE TERROIR
P. 250



VERTUO
P. 268



VINTAGE
P. 278

ALPHABETICAL TABLE OF CONTENTS

SOMMAIRE ALPHABÉTIQUE



Contenance
Capacity

75 cl
25.36 oz

Référence
Reference

3833

Bague
Finish



Poids
Weight

920 g
32.45 oz

Hauteur
totale [A]
Overall
height

305 mm
12.01 in

Diamètre
Pied [B]
Base
diameter

82,6 mm
3.25 in

Diamètre
Épaule [C]
Shoulder
diameter

95 mm
3.74 in

Diamètre de
débouchage
[D] Entrance
bore diameter

17,5 mm
0.69 in

Teinte
Glass color

● Antique
Antique Green
○ Extra Blanc
Extra White Flint

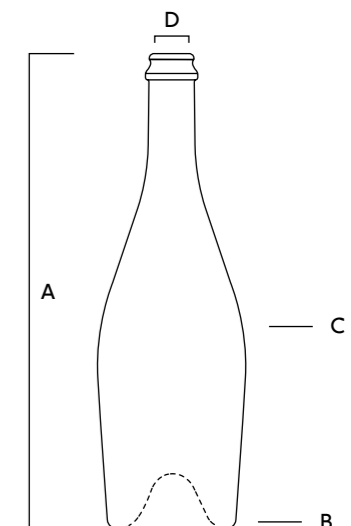

La silhouette d'ANASSA s'affranchit des traditions et séduit par un bas-fût conique, un très bel arrondi d'épaule ainsi qu'un col qui participent à l'impression de sveltesse proposée par ce modèle.

The ANASSA silhouette breaks with tradition with its seductive tapered based, attractive curved shoulder and a neck that contributes to the slenderness of this model's design.

CUVÉE DES SACRES



EXTRA PREMIUM



Digne héritière de la tradition Champenoise, la bouteille CUVÉE DES SACRES revendique les signes distinctifs des flacons d'exception d'autrefois: silhouette trapue et galbée, fût conique, épaule basse et profil de piqûre facilitant le service du sommelier.

The CUVÉE DES SACRES bottle is the rightful heir to the distinction associated with the best examples of champagne bottles from times gone by: a sturdy, curvaceous outline, tapering heel, low shoulder and substantial punt for ease of handling when pouring.



Contenance Capacity	75 cl 25.36 oz	150 cl 50.73 oz	300 cl 101.45 oz
Référence Reference	0420	2709	2710
Bague Finish	 Couronne Champ. 29	 Couronne Champ. 29	 Couronne Champ. 36
Poids Weight	900 g 31.75 oz	1750 g 61.73 oz	2925 g 103.17 oz
Hauteur totale [A] Overall height	285 mm 11.22 in	355,4 mm 13.99 in	436,2 mm 17.17 in
Diamètre Pied [B] Base diameter	87,9 mm 3.46 in	111 mm 4.37 in	137 mm 5.39 in
Diamètre Épaule [C] Shoulder diameter	100 mm 3.94 in	126,7 mm 4.99 in	156,4 mm 6.16 in
Diamètre de débouchage [D] Entrance bore diameter	17,5 mm 0.69 in	17,5 mm 0.69 in	19 mm 0.75 in
Teinte Glass color	● Antique Antique Green	● Antique Antique Green	● Antique Antique Green

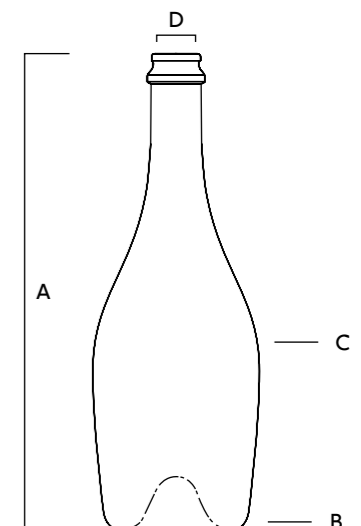

Modèle déposé « Design Saverglass »
Registered "Design Saverglass"

HÉRITAGE

EXTRA PREMIUM



Contenance
Capacity

75 cl
25.36 oz

Référence
Reference

2646

Bague
Finish



Poids
Weight

940 g
33.16 oz

Hauteur
totale [A]
Overall
height

300 mm
11.81 in

Diamètre
Corps [B]
Body
diameter

111 mm
4.37 in

Diamètre de
débouchage
[C] Entrance
bore diameter

17,5 mm
0.69 in

Teinte
Glass color

- Antique
Antique Green
- Extra Blanc*
Extra White Flint

Le modèle HÉRITAGE transgresse davantage les codes, misant sur le contraste entre la finesse de son col et l'ampleur évasée du bas-fût, offrant ainsi une conicité inversée des plus originales.

The HÉRITAGE model represents a deeper transgression of traditional codes, highlighting the contrast between the slim elegance of its neck and the flared breadth of its base, offering one of the most original inverse tapers.

* : Sur commande Made to order
Modèle déposé « Design Saverglass »
Registered "Design Saverglass"

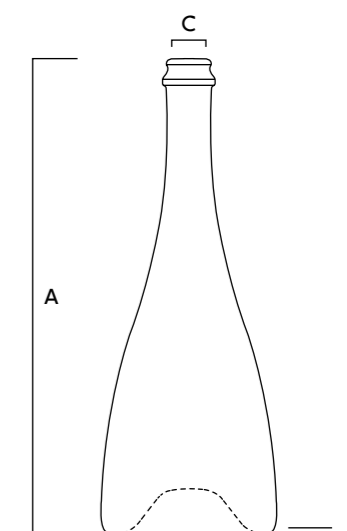

CHAMPENOISE TERROIR

EXTRA PREMIUM



A la faveur d'une jolie réinterprétation des bouteilles de champagne d'antan, les contours académiques de la CHAMPENOISE TERROIR gagnent en force pour exprimer la personnalité unique des vins de terroir. Cette silhouette unique se hisse désormais au rang de véritable icône et reste ainsi reconnaissable entre toutes : un long col gracile et cintré, une piqûre haute de forme carrée de 40 mm, des épaules marquées et un corps cylindrique puissant. Quant à son large plan de pose identitaire, il marque l'ancrage profond du flacon dans ce terroir exceptionnel et son authentique filiation avec le vignoble champenois.

A nod to the champagne bottles of yesteryear, the conventional contours of the CHAMPENOISE TERROIR are becoming more widely used to express the unique personality of the region's wines. This unique silhouette is proving itself as a real icon and is easily recognised: a long, sleek, sloped neck, a 40-mm deep square punt, pronounced shoulders and a powerful cylindrical body. As for its large base typical of the style, it marks the bottle's deep connection to this exceptional terroir and its authentic filiation with Champagne vineyards.



Contenance
Capacity

75 cl
25.36 oz

Référence
Reference

6641

Bague
Finish



Couronne & Carrée 29

Poids
Weight

950 g
33.51 oz

Hauteur
totale [A]
Overall
height

293,8 mm
11.57 in

Diamètre
Corps [B]
Body
diameter

101,6 mm
4.00 in

Diamètre de
débouchage [C]
Entrance
bore diameter

17,5 mm
0.69 in

Teinte
Glass color

● Antique
Antique Green

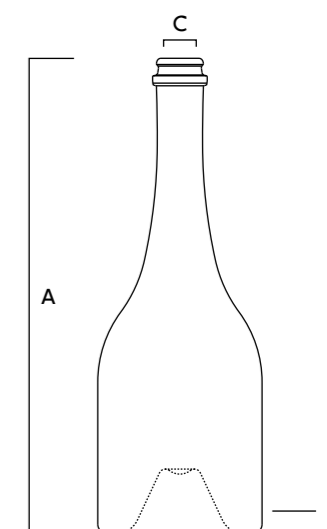

Modèle déposé « Design Saverglass »
Registered "Design Saverglass"

CHAMPENOISE CHORUS

SUPER PREMIUM



Flacon charismatique pour contenu d'exception, la bouteille CHORUS exprime son caractère généreux à travers un corps trapu, légèrement conique, et une épaule tombante qui vient souligner la spectaculaire finesse du col.

A seductive bottle to match its contents, CHORUS stands out with its generous lines, stocky slightly tapering body and sloping shoulder to accentuate the thinness of the neck design.



Contenance
Capacity

75 cl
25.36 oz

Référence
Reference

2392

Bague
Finish



Poids
Weight

941 g
33.19 oz

Hauteur
totale [A]
Overall
height

300,5 mm
11.83 in

Diamètre
Pied [B]
Base
diameter

98,6 mm
3.88 in

Diamètre
Épaule [C]
Shoulder
diameter

101,6 mm
4.00 in

Diamètre de
débouchage
[D] Entrance
bore diameter

17,5 mm
0.69 in

Teinte
Glass color

● Antique
Antique Green

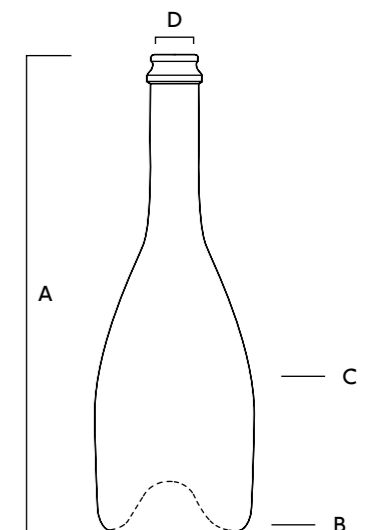

CHAMPAGNE GRAND CRU

SUPER PREMIUM



La bouteille Champagne GRAND CRU s'est imposée par sa ligne caractéristique comme un conditionnement de prestige. Ses qualités esthétiques et fonctionnelles, ses déclinaisons de teintes et de contenance font de ce modèle la référence des bouteilles de « Cuvées Spéciales ».

Because of its characteristic shape, the Champagne GRAND CRU bottle stands out as a Prestige container. Its aesthetic and functional qualities as well as its availability in different glass colors and in a wide range of capacities make it the reference for "Cuvées Spéciales" bottles.



Contenance
Capacity

75 cl
25.36 oz

150 cl
50.73 oz

Référence
Reference

0301

1135

Bague
Finish



Poids
Weight

900 g
31.75 oz

1750 g
61.73 oz

Hauteur
totale [A]
Overall
height

300 mm
11.81 in

367 mm
14.45 in

Diamètre
Corps [D]
Body
diameter

92,5 mm
3.64 in

120 mm
4.72 in

Diamètre de
débouchage
[E] Entrance
bore diameter

17,5 mm
0.69 in

17,5 mm
0.69 in

Teinte
Glass color

○ Extra Blanc
Extra White Flint
● Antique
Antique Green
● Champagne
Champagne Green

● Antique
Antique Green

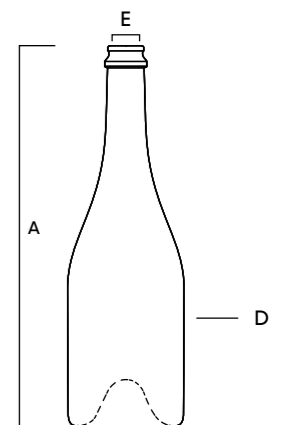

MILLÉSIME

SUPER PREMIUM



La Champenoise MILLÉSIME tire son élégance du contraste saisissant d'un corps opulent, prolongé d'une épaule galbée, avec un col fin et long. Ses sages mensurations et son fût cylindrique en font un contenant fort apprécié des manipulateurs.

The elegance of Champenoise MILLÉSIME stems from the striking contrast of an opulent body, extending into a curved shoulder and a long thin neck. Its sober dimensions and its cylindrical body, make it a container much appreciated by those handling it.



Contenance
Capacity

75 cl
25.36 oz

Référence
Reference

T101

Bague
Finish



Couronne Champ. 29

Poids
Weight

890 g
31.39 oz

Hauteur
totale [A]
Overall
height

300 mm
11.81 in

Diamètre
Corps [B]
Body
diameter

95,1 mm
3.74 in

Diamètre de
débouchage
[C] Entrance
bore diameter

17,5 mm
0.69 in

Teinte
Glass color

● Antique
Antique Green

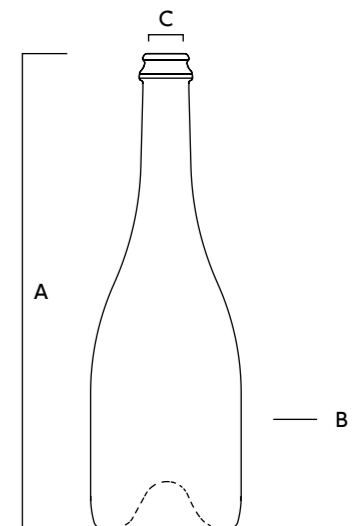

POMPADOUR

SUPER PREMIUM



Précieuse, raffinée et féminine, POMPADOUR rassure par la douceur de ses formes arrondies et la noblesse de son allure statutaire. Son long col effilé parachève admirablement l'ensemble.

POMPADOUR is a precious, refined and feminine bottle. Its rounded, statuesque body and long slender neck convey true nobility to this model.



Contenance
Capacity

75 cl
25.36 oz

75 cl
25.36 oz

Référence
Reference

4974*

4974

Bague
Finish



Couronne Champ. 29



Couronne & Carrée 29

Poids
Weight

940 g
33.16 oz

940 g
33.16 oz

Hauteur
totale [A]
Overall
height

300 mm
11.81 in

300 mm
11.81 in

Diamètre
Pied [B]
Base
diameter

86,2 mm
3.39 in

86,2 mm
3.39 in

Diamètre
Épaule [C]
Shoulder
diameter

104 mm
4.09 in

104 mm
4.09 in

Diamètre de
débouchage
[D] Entrance
bore diameter

17,5 mm
0.69 in

17,5 mm
0.69 in

Teinte
Glass color

○ Extra Blanc
Extra White Flint

● Antique
Antique Green

○ Extra Blanc
Extra White Flint

● Antique
Antique Green

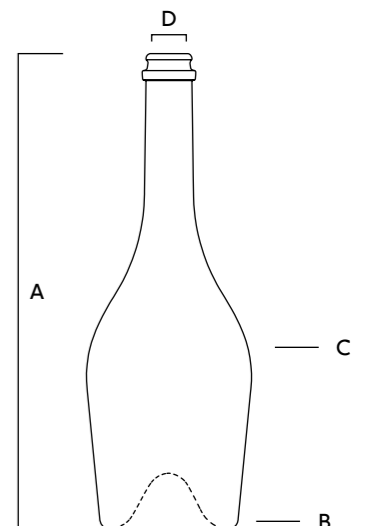

* : Sur commande Made to order
Modèle déposé « Design Saverglass »
Registered "Design Saverglass"

ARBANE

PREMIUM



Revisitant sobrement les codes d'expression Champenois, ARBANE mise sur l'élégance discrète. Valeur sûre, elle offre raffinement et confort d'utilisation pour une valeur perçue plus élevée.

ARBANE heralds a highly subtle evolution of traditional Champagne codes. It succeeds in conveying a forthright touch of elegance and refinement while offering genuine comfort in its handling and enhancing the image of the bottle.



Contenance Capacity	37,5 cl 12.68 oz	75 cl 25.36 oz	75 cl 25.36 oz	150 cl 50.73 oz
Référence Reference	5410	4975*	4975	5400
Bague Finish	 Couronne & Carrée 29	 Couronne Champ. 29	 Couronne & Carrée 29	 Couronne & Carrée 29
Poids Weight	500 g 17.64 oz	830 g 29.28 oz	830 g 29.28 oz	1750 g 61.73 oz
Hauteur totale [A] Overall height	243 mm 9.57 in	300 mm 11.81 in	300 mm 11.81 in	371,5 mm 14.63 in
Diamètre Corps [B] Body diameter	72,6 mm 2.86 in	91,2 mm 3.59 in	91,2 mm 3.59 in	118,2 mm 4.65 in
Diamètre de débouchage [C] Entrance bore diameter	17,5 mm 0.69 in	17,5 mm 0.69 in	17,5 mm 0.69 in	17,5 mm 0.69 in
Teinte Glass color	● Antique Antique Green	○ Extra Blanc Extra White Flint ● Antique Antique Green	○ Extra Blanc Extra White Flint ● Antique Antique Green	○ Extra Blanc Extra White Flint ● Antique Antique Green

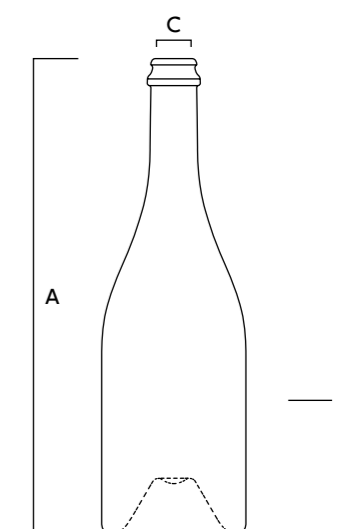

* : Sur commande Made to order
Modèle déposé « Design Saverglass »
Registered "Design Saverglass"

CRÉMANT PREMIUM

PREMIUM



Le design de CRÉMANT PREMIUM sied idéalement aux vins effervescents et autres méthodes traditionnelles, leur conférant un positionnement packaging haut de gamme. Conditionnement parfait pour ces vins jeunes, très plaisants, aux arômes riches et variés, CRÉMANT PREMIUM affiche un poids de verre optimisé à 780 g et une très belle silhouette élancée.

The CRÉMANT PREMIUM design is aimed at sparkling and traditional method wines that seek an up-market packaging positioning. CRÉMANT PREMIUM provides an ideal backdrop to young and pleasant wines that are rich and varied in aroma, and boasts a glass weight optimized at 780g and a highly attractive slender silhouette.



Contenance
Capacity

75 cl
25.36 oz

Référence
Reference

4574

Bague
Finish



Couronne Champ. 29

Poids
Weight

781 g
27.55 oz

Hauteur
totale [A]
Overall
height

315 mm
12.40 in

Diamètre
Corps [B]
Body
diameter

88,1 mm
3.47 in

Diamètre de
débouchage
[C] Entrance
bore diameter

17,5 mm
0.69 in

Teinte
Glass color

● Antique
Antique Green
○ Extra Blanc*
Extra White Flint

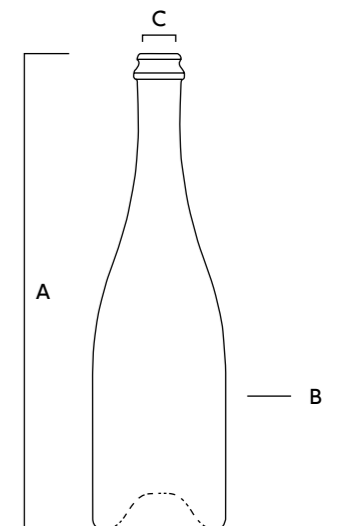

* : Sur commande Made to order

CRÉMANT PRESTIGE

PREMIUM



Contenance
Capacity

75 cl
25.36 oz

Référence
Reference

5645

Bague
Finish



Couronne Champ. 29

Poids
Weight

760 g
26.81 oz

Hauteur
totale [A]
Overall
height

300 mm
11.81 in

Diamètre
Corps [B]
Body
diameter

95,5 mm
3.76 in

Diamètre de
débouchage
[C] Entrance
bore diameter

17,5 mm
0.69 in

Teinte
Glass color

● Antique
Antique Green
○ Extra Blanc*
Extra White Flint

Réservée à l'élaboration des effervescents et méthodes traditionnelles, le modèle CRÉMANT PRESTIGE valorise l'image des vins frais et fruités en quête de positionnement haut de gamme. Doté d'un poids de verre optimisé à 760 g, ce flacon, caractérisé par sa silhouette élégante, habillera les vins avec raffinement.

The CRÉMANT PRESTIGE is aimed at the preparation of young, fruity and pleasant wines, sparkling and traditional method wines, which seek an up-market packaging positioning. With a glass weight optimized at 760g, this bottle, characterized by its elegant silhouette with perfect proportions, will show off your wines in a refined way.

* : Sur commande Made to order

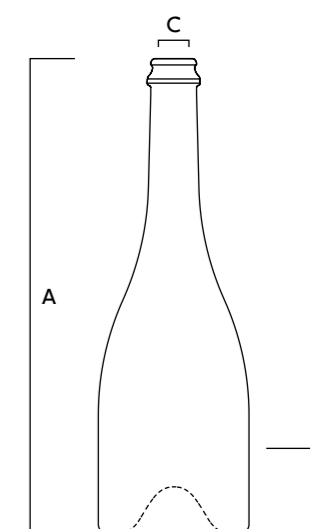

PRESTIGE MÉCANIQUE SWING TOP

PREMIUM



Contenance
Capacity

75 cl
25.36 oz

Référence
Reference

5645

Bague
Finish



Mécanique
Swing top

Poids
Weight

781 g
27.55 oz

Hauteur
totale [A]
Overall
height

315 mm
12.40 in

Diamètre
Corps [B]
Body
diameter

95,5 mm
3.76 in

Diamètre de
débouchage
[C] Entrance
bore diameter

17,2 mm
0.68 in

Teinte
Glass color

● Antique
Antique Green
○ Extra Blanc
Extra White Flint

La PRESTIGE MÉCANIQUE est réservée à l'élaboration de gammes effervescentes, de vins jeunes et fruités riches en arômes, ou de bières qui recherchent un positionnement packaging haut de gamme. D'un poids de verre optimisé à 780 g, ce flacon, caractérisé par sa silhouette élégante aux dimensions parfaites, habillera vos vins de façon raffinée. Autre atout du modèle: la possibilité d'adapter un bouchon mécanique, facilement réutilisable, durable et qui assure une conservation hermétique des boissons.

The PRESTIGE MÉCANIQUE is aimed at the preparation of young and fruity wines, sparkling wines, or beers which seek an up-market packaging positioning. With a glass weight optimized at 780g, this bottle which is characterised by its elegant silhouette with perfect proportions will show off your wines in a refined way. Another advantage of the design is the possibility of adapting a swing top stopper, easily reusable, sustainable and which ensures hermetic preservation of drinks.

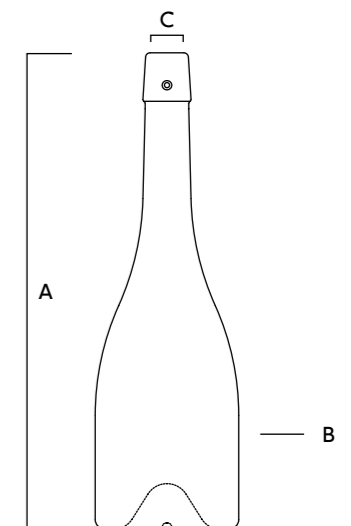

VERTUO

PREMIUM



VERTUO fait une entrée remarquable dans l'univers des vins effervescents, au point qu'elle pourrait bien devenir l'un des futurs must-have de la gamme ! Ses épaules douces, son col cintré délicat et son corps cylindrique adapté à toutes les méthodes de vinification signent une silhouette versatile parfaitement équilibrée. Sa hauteur de seulement 285,5 mm apporte une touche de sophistication empreinte de modernité. Vertuo s'accorde ainsi à merveille aux cuvées champenoises comme aux proseccos ainsi qu'à toutes les bulles festives, qu'elles soient fines ou intenses, complexes ou aériennes.

VERTUO has made such a remarkable entrance onto the sparkling wine scene that it could well become one of the range's must-haves in the future! A perfectly balanced versatile silhouette with soft shoulders, a delicate, sloped neck and cylindrical body suitable for all winemaking methods. And standing at just 285.5 mm, it looks sophisticated and modern. This makes Vertuo perfect for both Champagne cuvées and proseccos as well as for all kinds of bubbly used for celebrating, whether fine or intense, complex or refined.



Contenance
Capacity

75 cl
25.36 oz

Référence
Reference

6638

Bague
Finish



Couronne & Carrée 29

Poids
Weight

850 g
29.98 oz

Hauteur
totale [A]
Overall
height

285,5 mm
11.24 in

Diamètre
Corps [B]
Body
diameter

94,3 mm
3.71 in

Diamètre de
débouchage [C]
Entrance
bore diameter

17,5 mm
0.69 in

Teinte
Glass color

● Antique
Antique Green

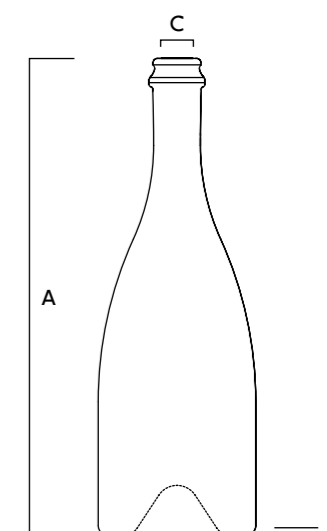

Modèle déposé « Design Saverglass »
Registered "Design Saverglass"

AUSTRAL & ORIGIN

STANDARD PREMIUM



D'une élégante simplicité, la Champenoise AUSTRAL séduit par sa singularité: un corps cylindrique assez trapu souligné par une hauteur de 278,8 mm. Révélant une silhouette sage, au design intemporel, la Champenoise AUSTRAL séduira par son élégance et sa grande aisance de manipulation.

La Champenoise ORIGIN adopte le même dimensionnel que le modèle Champenoise AUSTRAL mais se singularise par deux éléments différenciants: sa bague couronne & carrée et son imposante piqûre avec boudine.

Elegantly simple, the Champenoise AUSTRAL seduces with its uniqueness. Its stocky cylindrical body with a height of 278.8mm gives it a unique look. The Champenoise AUSTRAL reveals a wise silhouette and timeless design highly appreciated for its elegance and ease of handling.

The Champenoise ORIGIN adheres to the same dimensions as the Champenoise AUSTRAL yet stands out for two unique elements: its couronne & square finish and its deep punt with "a small push-out inside the punt".



AUSTRAL



ORIGIN

Contenance Capacity	75 cl 25.36 oz	75 cl 25.36 oz
Référence Reference	5231	5715
Bague Finish	 Couronne Champ. 29	 Couronne & Carrée 29
Poids Weight	890 g 31.39 oz	890 g 31.39 oz
Hauteur totale [A] Overall height	278,8 mm 10.98 in	278,8 mm 10.98 in
Diamètre Corps [B] Body diameter	95,5 mm 3.76 in	95,5 mm 3.76 in
Diamètre de débouchage [C] Entrance bore diameter	17,5 mm 0.69 in	17,5 mm 0.69 in
Teinte Glass color	● Antique Antique Green	● Antique Antique Green ○ Extra Blanc Extra White Flint

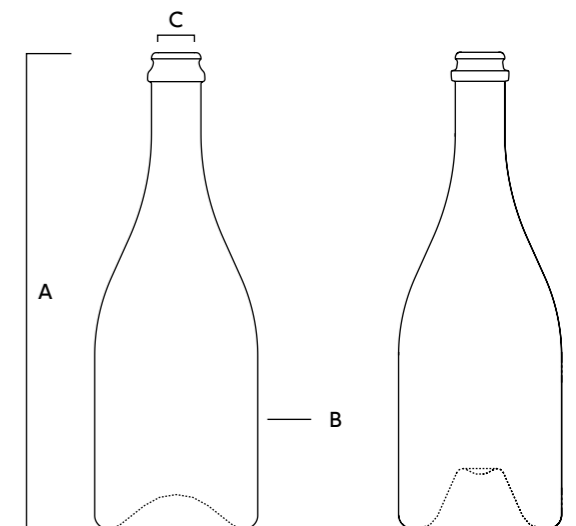

CRÉMANT CLASSIC

STANDARD PREMIUM



Conçu pour servir la cause des Vins Effervescents, le modèle CRÉMANT CLASSIC allie design soigné et fonctionnel: des proportions équilibrées, un fût cylindrique fortement apprécié par les Manipulants, une droite étiquetable à l'épaule, et surtout un poids de verre optimisé de 800 g.

Designed for sparkling wines, the CRÉMANT CLASSIC model combines meticulous and functional design: balanced proportions, a cylindrical bottle—much appreciated by those handling it—an area for easy labelling on the shoulder, and in particular, an optimised glass weight of 800 g.



Contenance
Capacity

75 cl
25.36 oz

Référence
Reference

6717

Bague
Finish



Couronne de 29

Poids
Weight

800 g
28.22 oz

Hauteur
totale [A]
Overall
height

300 mm
11.81 in

Diamètre
Corps [B]
Body
diameter

85,9 mm
3.38 in

Diamètre de
débouchage [C]
Entrance
bore diameter

17,5 mm
0.69 in

Teinte
Glass color

● Antique
Antique Green

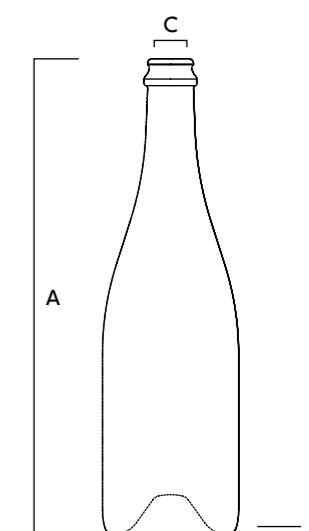

CHAMPENOISES STANDARD & ÉCO DESIGN

STANDARD PREMIUM



Déclinée de la version originelle de la Champenoise STANDARD, la Champenoise ÉCO DESIGN propose une version accessible tout en revendiquant un strict respect de la ligne dont elle est issue, la conservation de ses qualités de praticité liées à ses caractéristiques dimensionnelles. Ce modèle se caractérise notamment par un poids modeste de 835 g.

Avec une gamme de contenances qui s'étend depuis le quart jusqu'au format 6 L, le modèle Champenoise STANDARD représente un support idéal pour tous les vins effervescents. Un soin particulier est apporté à la disponibilité des teintes autres que la teinte Champagne, telles que l'Antique et l'Extra Blanc, ainsi qu'à des versions de bagues.

Available as an original version of the Champagne STANDARD bottle, the Champenoise ÉCO DESIGN offers an accessible version while demanding strict adherence to the line from which it hails and the preservation of its convenience-related qualities linked to dimensional features. This model is characterized in particular by its modest weight of 835g.

The Champenoise STANDARD range extends from 20cl to 6L capacities, and represents an ideal model for any sparkling wine. In addition to the Champagne green color, particular care has been taken to provide a wide choice of glass colors, such as Antique Green or Extra White Flint, as well as other finishes.

CHAMPENOISES STANDARD & ÉCO DESIGN

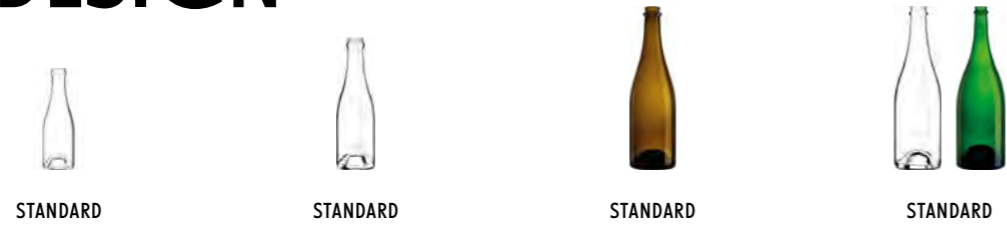

STANDARD STANDARD STANDARD STANDARD

Contenance Capacity	20 cl 6.76 oz	37,5 cl 12.68 oz	75 cl 25.36 oz	75 cl 25.36 oz
Référence Reference	0729*	0725	0771	0771
Bague Finish	 MCA275	 Couronne Champ. 29	 Couronne & Carrée 29	 Couronne Champ. 29
Poids Weight	250 g 8.82 oz	500 g 17.64 oz	900 g 31.75 oz	900 g 31.75 oz
Hauteur totale [A] Overall height	185,7 mm 7.31 in	243,5 mm 9.59 in	300 mm 11.81 in	300 mm 11.81 in
Diamètre Pied [B] Base diameter	- -	- -	- -	- -
Diamètre Épaule [C] Shoulder diameter	- -	- -	- -	- -
Diamètre Corps [D] Body diameter	58,6 mm 2.31 in	70,6 mm 2.78 in	88,4 mm 3.48 in	88,4 mm 3.48 in
Diamètre de débouchage [E] Entrance bore diameter	17,5 mm 0.69 in	17,5 mm 0.69 in	17,5 mm 0.69 in	17,5 mm 0.69 in

Teinte Glass color	○ Extra Blanc Extra White Flint	● Antique* Antique Green ○ Extra Blanc Extra White Flint ● Champagne Champagne Green	● Antique Antique Green	○ Extra Blanc Extra White Flint ● Champagne Champagne Green
-----------------------	------------------------------------	---	----------------------------	--



ÉCO DESIGN STANDARD STANDARD STANDARD STANDARD

Contenance Capacity	75 cl 25.36 oz	150 cl 50.73 oz	300 cl 101.45 oz	300 cl 101.45 oz	600 cl 202.91 oz
Référence Reference	4435	0685	0718	0718	1742
Bague Finish	 Couronne Champ. 29	 Couronne Champ. 29	 Couronne Champ. 36	 Carrée Champ. 36	 Carrée
Poids Weight	835 g 29.45 oz	1730 g 61.02 oz	3030 g 106.88 oz	3030 g 106.88 oz	5130 g 180.95 oz
Hauteur totale [A] Overall height	300 mm 11.81 in	371,5 mm 14.63 in	470,3 mm 18.52 in	474,3 mm 18.67 in	571 mm 22.48 in
Diamètre Pied [B] Base diameter	- -	- -	133,2 mm 5.24 in	133,2 mm 5.24 in	170 mm 6.69 in
Diamètre Épaule [C] Shoulder diameter	- -	- -	135,2 mm 5.32 in	135,2 mm 5.32 in	174 mm 6.85 in
Diamètre Corps [D] Body diameter	88,2 mm 3.47 in	114,5 mm 4.51 in	- -	- -	- -
Diamètre de débouchage [E] Entrance bore diameter	17,5 mm 0.69 in	17,5 mm 0.69 in	17,5 mm 0.69 in	19 mm 0.75 in	20,5 mm 0.81 in

Teinte Glass color	● Antique Antique Green ○ Extra Blanc Extra White Flint ● Champagne Champagne Green	● Antique Antique Green ○ Extra Blanc* Extra White Flint ● Champagne Champagne Green	● Antique* Antique Green ● Champagne Champagne Green	● Champagne Champagne Green	● Champagne Champagne Green
-----------------------	--	---	---	--------------------------------	--------------------------------

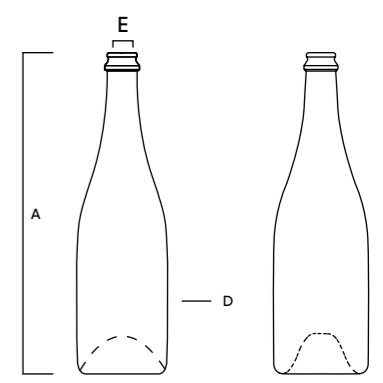

*: Sur commande Made to order

VINTAGE

STANDARD PREMIUM



La Champenoise VINTAGE est un modèle Champenois qui s'inspire des codes d'antan tout en affichant un caractère résolument moderne. Fluidité et élégance caractérisent sa silhouette. Son col long et fin ajoute de la noblesse à ce flacon d'exception. Ses qualités fonctionnelles, son corps cylindrique, ses déclinaisons de teintes, en font le modèle de référence des cuvées Champenoises.

The Champenoise VINTAGE model is inspired by the styles of the past while at the same time maintaining a resolutely modern character. Fluidity and elegance characterize the silhouette of Champenoise VINTAGE. Its long and thin neck adds a touch of nobility to this exceptional bottle. Its functional qualities, cylindrical body and color range make it the benchmark for the best Vintage Champagnes.



Contenance
Capacity

75 cl
25.36 oz

Référence
Reference

5403

Bague
Finish



Poids
Weight

860 g
30.34 oz

Hauteur
totale [A]
Overall
height

300 mm
11.81 in

Diamètre
Corps [B]
Body
diameter

96,5 mm
3.80 in

Diamètre de
débouchage
[C] Entrance
bore diameter

17,5 mm
0.69 in

Teinte
Glass color

- Antique
Antique Green
- Extra Blanc
Extra White Flint
- Champagne
Champagne Green

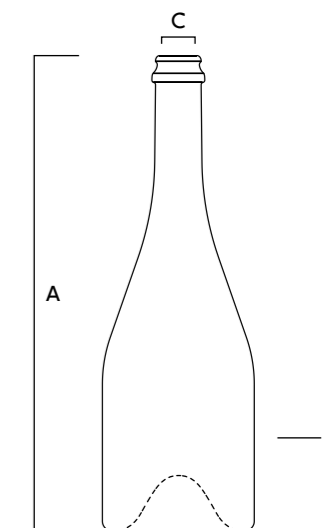

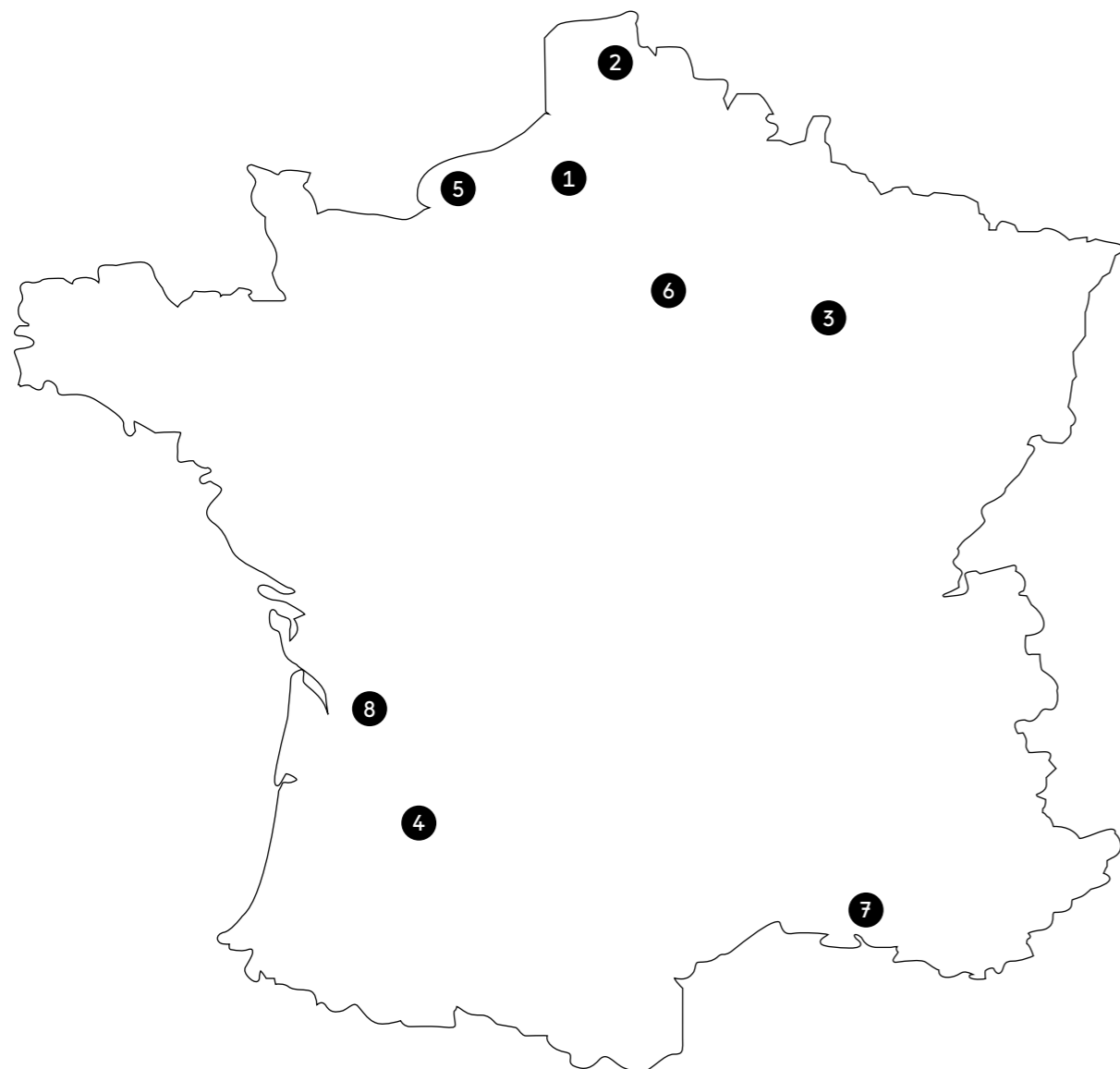

1 SAVERGLASS

France - Feuquières
Siège Social et Usine verre et décor
Headquarter and glass and decoration factory
▼▲■
3, Place de la Gare
60960 Feuquières
T +33 (0)3 44 46 45 45

2 ALPHAGLASS – ALPHADEC

France - Arques
▼▲
Zone Industrielle du Hocquet
62510 Arques
T +33 (0)3 21 11 50 50

3 SAVERGLASS CHAMPAGNE

France - Pierry
●
Pôle d'activités Saint Julien
Allée Maxenu
51530 Pierry
T +33 (0)3 26 58 17 85

4 V.D.A. Verreries et Décors d'Armagnac

France - Condom
●
Route de Nérac - Z.I. de Pôme
32100 Condom
T +33 (0)5 62 68 30 10

5 TOURRES & CIE

France - Le Havre
▼
111, rue de la Vallée
CS 95010
76071 Le Havre Cedex
T +33 (0)2 35 55 28 28

6 SAVERPLUS

France - Coulommiers
▲
9, 11 rue de l'Aubetin
77120 Coulommiers
T +33 (0)1 64 75 82 82

7 SAVERSUD

France - Venelles
●
VenelTech - Bat. A2
994 rue de la Gare
13770 Venelles
T +33 (0)4 42 90 40 17

8 SAVERGLASS COGNAC

France - Cognac
■●
Z.I. de Merpins
rue Jacques Marzio
16100 Merpins
T +33 (0)5 45 82 35 79

CONTACTEZ-NOUS

CONTACT US

www.saverglass.com

SAVERGLASS IN FRANCE

SAVERGLASS EN FRANCE

▼ Usines verre
Glass factories

▲ Usines décor
Decoration factories

● Filiales et Bureaux
Subsidiaries and Offices

■ Showrooms
Showrooms



EUROPE EUROPA

1 SAVERGLASS IBERICA

Portugal – Sintra
Portugal – Sintra
■ ●
Avenida Almirante
Gago Coutinho, 132 - 134, Edificio 2
2710-418 Sintra – Portugal
T +351 21 924 80 60 / 61 / 62

2 SAVERGLASS IBERICA

Espagne – Madrid
Spain – Madrid
■ ●
Plaza Carlos Trías Bertrán, 4
1ª Planta
Ibercenter Business Center
28020 Madrid – Spain
T +(34) 91 418 45 09

3 SAVERGLASS ITALIA

Italie – Milan
Italy – Milan
■ ●
Via Lazzaretto, 19
20124 Milano – Italia
T +(39) 024 549 0078

4 SAVERGLASS RUSSIA

Russie – Moscou
Russia – Moscow
●
Zubovski proezd 2
Build. 1, office 3.
Moscow, 119021 – Russia
T +7 (495) 780 0580

5 SAVERGLASS UK

Royaume-Uni
United Kingdom
●
Angleterre & Pays de Galles
England & Wales
T +44 (0) 7703 184200
—
Écosse & Irlande
Scotland & Ireland
T +44 (0) 7538 651337

6 SAVERGLASS GHLIN

Belgique
Belgium
▼
Rue des Ayettes
7011 Ghlin, Belgique

AMÉRIQUE DU NORD NORTH AMERICA

7 SAVERGLASS USA

États-Unis – Californie
U.S.A. – California
■ ●
2950 Cordelia Rd,
Fairfield CA 94534 – USA
T +1 (707) 259 2930

8 SAVERGLASS USA

États-Unis – Kentucky
U.S.A. – Kentucky
■ ●
607 W Main St.
Suite 401
Louisville KY 40202 – USA
T +1 502 365 2333

9 SAVERGLASS USA

États-Unis – New Jersey
U.S.A. – New Jersey
●
107 Spring Street
Suite 210
Ramsey NJ 07446 – USA
T +1 (201) 825 7100

10 SAVERGLASS MEXICO

Mexique - Acatlan de Juarez
Mexico - Acatlan de Juarez
▼▲
Carretera Libre Acatlan de Juarez
a Cd. Guzman Km 11
Centro Logistico Jalisco
Area Industrial
45713 Acatlan de Juarez, Jalisco
Mexico

11 SAVERGLASS MEXICO

Mexique - Guadalajara
Mexico - Guadalajara
●
Torre Ganesh
Ahuizotl #2276, Cd del Sol
45050 Zapopan
Guadalajara, Jalisco – Mexico
T +(52) 1 33 3884 0900

AUSTRALIE AUSTRALIA

12 SAVERGLASS AUSTRALIA

Australie – Adelaide
Australia – Adelaide
■ ●
289 Flinders Street,
PO Box 6537 (Halifax street)
Adelaide SA 5000 – Australia
T +61 (08) 8232 0770

13 SAVERGLASS AUSTRALIA

Australie – Melbourne
Australia – Melbourne
■ ●
Level 2, 7 River Street,
South Yarra, Victoria 3142
Melbourne – Australia
T +61 (39) 4138 1300

14 SAVERGLASS NEW ZEALAND

Nouvelle Zélande – Auckland
New Zealand – Auckland
●
PO Box
Symonds St
Auckland 1150 – New Zealand
T +64 9 522 2990

AFRIQUE MOYEN-ORIENT AFRICA MIDDLE EAST

15 SAVERGLASS SOUTH AFRICA

Afrique du Sud – Somerset West
South Africa – Somerset West
●
P.O. Box 333
Somerset Mall, 7137 – South Africa
T +27 (021) 851 0005

16 SAVERGLASS UNITED ARAB EMIRATES

E.A.U. – Ras al Khaimah
U.A.E. – Ras al Khaimah
▼
Al Jazeerah - Al Hamra
PO Box 86333
Ras al Khaimah
United Arab Emirates
T +971 7 203 4800

CONTACTEZ-NOUS
CONTACT US
www.saverglass.com

SAVERGLASS se réserve le droit de modifier ou de supprimer certains modèles figurant dans les gammes présentées, ou de supprimer certaines versions de contenance, de teinte ou de bouchage. Les éléments techniques dans ce catalogue, et notamment les caractéristiques dimensionnelles des articles, n'ont qu'un caractère indicatif. Ils ne peuvent être utilisés en l'état pour la vérification de compatibilité sur lignes d'embouteillage, problème de machinabilité ou pour l'étude de processus d'habillage (étiquetage, bouchage, capsulage, parachèvement, ...) et de compatibilité de sur-emballage. Pour ce faire, SAVERGLASS recommande l'utilisation de ses plans verriers en vigueur et d'échantillons verre disponibles sur simple demande.

SAVERGLASS est titulaire de tous les droits de propriété intellectuelle (brevets, droit d'auteur, dessin, modèle, marque et autres) afférents, relatifs et/ou attachés aux modèles dits « Design Saverglass » et aux modèles personnalisés ou déclinés des modèles « Design Saverglass », ainsi qu'aux articles représentant ou reproduisant ces modèles, ce que reconnaît le Client qui s'interdit de se prévaloir ou de revendiquer un quelconque droit de propriété de la nature de ceux précités sur lesdits modèles, comme de les reproduire ou les représenter ou les faire reproduire ou représenter par un tiers, notamment sous forme de cols verriers quels que soit leur usage et leur destination. SAVERGLASS est également titulaire de tous droits de propriété sur tous les plans verriers, plans projets, plans 3D, dessins, modèles, maquettes, échantillons, typons, ébauches, croquis, projets, études, moules et autres documents techniques ou artistiques de toute nature qui émanent de sa part et peuvent, dans leurs rapports commerciaux, et à la discrétion de SAVERGLASS, être adressés au Client. Le Client s'interdit expressément de divulguer ceux-ci comme d'en faire un quelconque usage autre que dans le cadre de ses seuls rapports commerciaux avec SAVERGLASS.

SAVERGLASS reserves the right to modify or delete any of the designs shown, and to delete any sizes, colours or corking versions. The technical features stated in this catalogue, and in particular the dimensions of the items, are intended only as a guide. They cannot be used "as-stated" for checking compatibility on bottling lines, for checking machining problems, or to assess the decorating process (labelling, corking, capping, finishing, etc.) or the compatibility of primary or second packaging. SAVERGLASS recommends using the glass drawings and samples available by simple request for this purpose.

SAVERGLASS is the holder of all intellectual property rights (patents, copyrights, drawings, designs, trademarks and others) pertaining to, relating to and/or associated with "Design Saverglass" designs and with customised or adjusted "Design Saverglass" designs, as well as with all items representing or copying those designs, the Client acknowledging the foregoing and agreeing to refrain from using or challenging any of the aforesaid intellectual property rights to said designs, including reproducing these or having these reproduced by a third party, particularly in the form of a bottleneck, regardless of its use or purpose. SAVERGLASS is also the holder of all ownership rights to all glasswork plans, project plans, 3D plans, drawings, templates, mock-ups, samples, artwork, drafts, sketches, projects, studies, moulds, and other technical or artistic documents of any kind issued by it and that may, in business relationships and at the discretion of SAVERGLASS, be enforceable against the Client. The Client expressly undertakes to refrain from disclosing any of the above as well as from any usage that does not fall within the scope of its business relationships with SAVERGLASS.

